

# jandel

CATÁLOGO TARIFA  
2023



Manivelas  
y complementos  
para puertas



**jandel**

¡ Bienvenid@ a casa !

Diferentes estilos

Diferentes necesidades

Diferentes series

UNA MISMA MARCA





## DISEÑO FABRICACIÓN DISTRIBUCIÓN

Siguiendo las tendencias del mercado, Jandel presenta su nuevo catálogo aumentando la gama de productos en manivelas, manillones, pomos, tiradores y complementos.

Nuestro compromiso con los clientes y con la arquitectura hace que busquemos maneras nuevas y creativas de resolver los retos que se nos presentan cada día.

Buscamos la EXCELENCIA ya que aspiramos a los más altos estándares de calidad, eficiencia y servicio.

¡Gracias por acompañarnos en este camino.!



## CUIDAMOS NUESTRO PLANETA

### GESTIÓN DE RESIDUOS

En Jandel estamos comprometidos en disminuir los residuos generados como consecuencia de las actividades humanas, y así contribuir a reducir sus impactos a fin de minimizar los potenciales daños que causan al hombre y al medio ambiente.

### DESENGRASE DE METÁLES

Para las industrias en las que el proceso de producción incluye la fabricación o montaje de componentes metálicos, es fundamental una limpieza efectiva de grasas, aceites, taladrinas, desmoldeantes, etc. Nuestros artículos pasan por diferentes equipos para realizar esta operación, siempre con lavado de agua y productos biodegradables.



## CUIDAMOS LOS DETALLES

### EMBALAJE ECOLÓGICO

El packaging de nuestros artículos es respetuoso con el medio ambiente.

Apostamos por embalajes ecológicos, por ello hemos implementado el uso de materiales reciclados y reciclables.



Certificado ES18/82893  
El sistema de gestión de  
**JANDEL, S.L.**



C/ Dels Fusters, 19, Pol. Ind. Els Molons, 46970 Alaquàs, Valencia  
ha sido evaluado y certificado que cumple con los requisitos de  
**ISO 9001:2015**  
Para las siguientes actividades  
Diseño y comercialización de herrajes para puertas y ventanas.

Este certificado es válido desde 19 de diciembre de 2022 hasta 13 de agosto de 2024 y su validez está sujeta al resultado satisfactorio de las auditorías de seguimiento.  
Edición 4. Certificada con SGS desde 13 de agosto de 2018.  
Expiración del ciclo anterior: 13/08/2021.  
Auditoría de renovación: 01/10/2021.

Autorizado por \_\_\_\_\_  
SGS International Certification Services Iberica, S.A.U.  
C/Trespaderne, 29. 28042 Madrid, España  
t +34 91 313 8115 - www.sgs.com



Este documento es un certificado electrónico auténtico para el uso comercial del Cliente únicamente. Está permitida la versión impresa del certificado electrónico y se considerará como una copia. Este documento es emitido por la Compañía sujeta a las Condiciones Generales de SGS de los servicios de certificación disponibles en los términos y condiciones | SGS. Se prestará especial atención sobre las cláusulas de limitación de responsabilidad, indemnización y jurisdicción que contiene. Este documento está protegido por derechos de autor y cualquier alteración, falsificación o modificación no autorizada de su contenido o apariencia es ilegal.



**CERTIFICADO DE CALIDAD ISO 9001-20158**  
Es la norma internacional más reconocida.  
Se centra en todos los elementos de administración de calidad con los que una organización debe contar para tener un sistema efectivo que le permita mejorar su productos y servicios. En Jandel estamos orgullosos de haber implantado esta norma.

## **TÉRMINOS Y CONDICIONES GENERALES DE VENTA (CGV)**

### **1.- Ámbito de aplicación**

Las presentes condiciones generales se aplicarán a todas las ventas y se entenderán aceptadas totalmente por los clientes por el sólo hecho de realizar un pedido, o aceptar una oferta.

### **2.- Precios.**

Esta Tarifa anula las anteriores.

Los precios que en ella figuran se expresan en euros (€) y sin impuestos.

Esta tarifa permanecerá vigente en tanto no se comunique cualquier cambio por parte de Jandel S.L.

### **3.- Pedidos**

El importe mínimo de un pedido deberá ser de 50,00 € (sin IVA).

Los modelos o acabados que NO figuran en esta tarifa quedan anulados o son susceptibles de consulta.

La mercancía viaja a Portes PAGADOS en:

Península y Baleares, para pedidos con importe = o superior a 300€ (sin IVA)

Canarias, Ceuta y Melilla, para pedidos con importe = o superior a 800€ (sin IVA)

### **4.- Entrega de las mercancías.**

a) EL COMPRADOR DISPONDRÁ DE UN PLAZO MÁXIMO DE 5 DÍAS A PARTIR DE LA RECEPCIÓN DE LA MERCANCÍA PARA ENVIAR POR ESCRITO CUALQUIER RECLAMACIÓN POR DESPERFECTOS EN CALIDAD O DISCREPANCIA EN LA CANTIDAD ENVIADA.

b) en el caso de que se perciban daños exteriores en el embalaje de la mercancía, es NECESARIO que presente reservas a la agencia de transporte, y ésta lo refleje en el comprobante de entrega con una descripción detallada.

### **5.- Política de devoluciones de mercancía.**

- Solo se contemplarán cambios o devoluciones si nuestros productos presentan algún tipo de TARA. Fuera de esta condición, únicamente se aceptarán aquellas devoluciones que estén autorizadas previamente por el departamento Comercial, siendo los costes del envío a cargo del comprador.
- La mercancía devuelta con antigüedad superior a dos años tendrá un RECARGO del 30% en concepto de manipulación y gastos de gestión.
- En toda devolución se tendrá que aportar el número de Albarán o Factura de compra.
- Quedan EXCLUIDOS, de la política de devoluciones los productos especiales o personalizados.

Es importante que sigan las “especificaciones de mantenimiento” que recomendamos:

< Para la limpieza de nuestros artículos barnizados, pasar sólo un paño seco, sin emplear ningún producto químico, ya que tales productos afectan a la composición del barniz alterando sus propiedades, y por tanto afectando la calidad de dicho artículo >

### **6.- Modo de pago.**

El retraso en el pago de las facturas ocasionará la aplicación de intereses de DEMORA.

En el caso de producirse IMPAGADOS, hará que se RETENGAN los pedidos hasta la total cancelación del saldo a favor de Jandel sl.

La presentación por parte del comprador de disconformidades o reservas en la mercancía no exime de la obligación de pago de la Factura en la fecha acordada.

### **7.- Información contenida en catálogos y en la web.**

La información contenida en la tarifa- catálogo y en su web, con respecto a las descripciones, imágenes y medidas tendrá un valor meramente orientativo y aproximado, de modo que la empresa no asumirá ninguna responsabilidad por las posibles inexactitudes que puedan existir.

Jandel, S.L. SE RESERVA EL Der. DE EFECTUAR CUALQUIER MODIFICACIÓN O ANULACIÓN DE MODELOS Y ACABADOS OFRECIDOS SIN PREVIA COMUNICACIÓN.

#### JANDEL PREMIUM

Manijas .....	16
Bases.....	29
Grisanes .....	30
Manillones .....	31
Alzantes.....	34
Complementos .....	36

#### JANDEL ORIGINAL

Manijas .....	44
Bases.....	73
Manillones .....	74
Grisanes .....	82
Pomos de puerta .....	84
Complementos .....	88

#### JANDEL EQUAL

Manijas .....	96
Manillones .....	114
Complementos .....	124
Accesorios Técnicos.....	133

#### JANDEL INOX

Manijas .....	135
Manillones .....	140
Complementos .....	148
Pomos .....	151

JANDEL TIRADORES MUEBLE.....	152
------------------------------	-----

# INDICE

## JANDEL PREMIUM

 <b>NEW</b> 1301 ..... 16	 <b>NEW</b> 3310 ..... 21	 6318 ..... 27	 <b>NEW</b> C338 ..... 33	 38BY ..... 38
 <b>NEW</b> 1311 ..... 16	 3327 ..... 21	 6328 ..... 27	 <b>NEW</b> 102AL2 ..... 34	 38BO ..... 38
 1320 ..... 16	 3337 ..... 22	 6338 ..... 28	 <b>NEW</b> 359AL2 ..... 34	 38WC ..... 38
 <b>NEW</b> 1327 ..... 17	 3357 ..... 23	 6347 ..... 28	 <b>NEW</b> 168AL2 ..... 35	 39BY ..... 38
 1348 ..... 18	 3367 ..... 23	 <b>BASES</b> ..... 29	 13BY ..... 36	 39BO ..... 38
 1356 ..... 18	 3377 ..... 23	 CG66 ..... 30	 13BO ..... 36	 39WC ..... 38
 1358 ..... 18	 3378 ..... 24	 CG20 ..... 30	 13WC ..... 36	 63BY ..... 39
 1366 ..... 19	 3388 ..... 25	 G88C ..... 30	 <b>NEW</b> MARIONWC ..... 36	 63BO ..... 39
 <b>NEW</b> 1369 ..... 19	 3398 ..... 25	 C349 ..... 31	 33BY ..... 37	 63WC ..... 39
 <b>NEW</b> 1379 ..... 19	 3720 ..... 25	 EQ-M802 ..... 31	 33BO ..... 37	 01WC ..... 39
 1388 ..... 20	 3766 ..... 26	 C327 ..... 31	 33WC ..... 37	 03WC ..... 39
 1397 ..... 20	 3887 ..... 26	 <b>NEW</b> C379 ..... 32	 37BY ..... 37	 CXBY ..... 40
 1398 ..... 20	 <b>NEW</b> 3889 ..... 26	 <b>NEW</b> C369 ..... 32	 37BO ..... 37	 CXBO ..... 40
 <b>NEW</b> 1399 ..... 21	 3976 KUBO ..... 27	 <b>NEW</b> C348 ..... 33	 37WC ..... 37	 CXBYC ..... 40



## JANDEL ORIGINAL

				
CXBOC ..... 40	1023 ..... 44	1224 ..... 47	KAROL ..... 50	SV-R950 ..... 55
				
C630 ..... 41	1045 ..... 44	1229 ..... 47	EQ-R207 ..... 51	SV-C650 ..... 55
				
C635 ..... 41	1059 ..... 44	1234 ..... 47	EQ-R208 ..... 51	SV-C950 ..... 55
				
7610 ..... 41	1072 ..... 44	1239 ..... 47	EQ-R209 ..... 51	3012 ..... 56
				
7630 ..... 41	1075 ..... 44	1249 ..... 47	EQ-R450 ..... 51	3022 ..... 56
				
75220 ..... 42	1080 ..... 44	1254 ..... 47	<b>NEW</b> EQ-R653 ..... 51	3070 ..... 56
				
75200 ..... 42	1082 ..... 45	<b>NEW</b> 12TE ..... 48	<b>NEW</b> EQ-R657 ..... 51	3080 ..... 56
				
75420 ..... 42	1090 ..... 45	<b>NEW</b> 15TE ..... 48	EQ-R890 ..... 52	3082 ..... 56
				
75400 ..... 42	1092 ..... 45	<b>NEW</b> WCTE ..... 48	EQ-R891 ..... 52	3413 ..... 56
				
9510 ..... 43	1105 ..... 45	<b>NEW</b> HQTE ..... 48	EQ-R892 ..... 52	3424 ..... 56
				
9530 ..... 43	1115 ..... 46	<b>NEW</b> H2TE ..... 48	UOVO ..... 54	3429 ..... 57
				
1209 ..... 46	1264 ..... 50	POLO PORCELANA ..... 54	3434 ..... 57	
				
1213 ..... 46	2040 ..... 50	POLO ..... 54	3449 ..... 57	
				
1219 ..... 46	6042 ..... 50	SV-R650 ..... 55	3570 ..... 59	

# INDICE

## JANDEL ORIGINAL

				
4513 ..... 59	EQ-796 ..... 64	PLACAS ..... 73	C327 ..... 78	C209 ..... 87
				
SV-PC65 ..... 59	EQ-1599 ..... 64	C302 ..... 74	C322 ..... 79	C605 ..... 88
				
SVP650 ..... 59	EQ-2733 ..... 65	EQ-M890 ..... 74	C326 ..... 79	C606 ..... 88
				
3223 ..... 60	EQ-3800 ..... 65	EQ-M891 ..... 74	C359 ..... 81	SV-BR25 ..... 88
				
 EQ-9690 ..... 60	EQ-4402 ..... 66	EQ-M892 ..... 74	C800 ..... 81	EQ-285Z ..... 88
				
 EQ-9691 ..... 60	EQ-4406 ..... 66	C307 ..... 75	CG75 ..... 82	C608 ..... 89
				
 EQ-9692 ..... 60	EQ-4419 ..... 67	C308 ..... 75	CGKA ..... 82	SV-CR50 ..... 89
				
8045 ..... 61	EQ-4423 ..... 68	C309 ..... 75	G13C ..... 83	C630 ..... 89
				
1605 ..... 61	EQ-4424 ..... 68	C310 / C312 ..... 75	SV-105P ..... 84	12BY ..... 89
				
 4459 ..... 61	EQ-4450 ..... 69	C311 ..... 76	C207 ..... 84	SV-495 ..... 90
				
EQ-100B ..... 62	EQ-8300 ..... 69	C313 ..... 76	C208 ..... 84	C611 ..... 91
				
EQ-297 ..... 62	EQ-9500 ..... 70	C316 ..... 76	EQ-1085 ..... 85	34BY ..... 91
				
EQ-330 ..... 63	EQ-9501 ..... 70	C320 ..... 77	EQ-1095 ..... 85	C635 ..... 91
				
EQ-525 ..... 63	EQ-9600 ..... 71	C349 ..... 77	C210 ..... 86	C902 ..... 91

## JANDEL EQUAL



12WC ..... 92



C621 ..... 92



34WC ..... 92



SV-CC35 ..... 92



7610 ..... 93



7630 ..... 93



7510 ..... 93



7530 ..... 93



C410 ..... 94



C420 ..... 94



C450 ..... 94



C460 ..... 94

NEW



EQ-T490-91-92...95

NEW



EQ-A490-91-92...95



EQ-202 ..... 96



EQ-203 ..... 96



EQ-204 ..... 96



EQ-205 ..... 96



EQ-206 ..... 97



EQ-207 ..... 97



EQ-208 ..... 97



EQ-209 ..... 97



EQ-210 ..... 98



EQ-868 ..... 98



EQ-R150 ..... 101



EQ-R200 ..... 101



EQ-R204 ..... 101



SV-R250 ..... 101



SV-R300 ..... 102



SV-R333 ..... 102



SV-R350 ..... 102



SV-R600 ..... 102



SV-R700 ..... 103



SV-R800 ..... 103



SV-R850 ..... 103



EQ-R655 ..... 103



EQ-C150 ..... 104



SV-C200 ..... 104



SV-C350 ..... 104



SV-C400 ..... 104



SV-C700 ..... 104



SV-C750 ..... 104



SV-P150 ..... 108



SV-P200 ..... 108



SV-P250 ..... 108



SV-P300 ..... 108



SV-P333 ..... 108



SV-P350 ..... 109



SV-P600 ..... 109



SV-P850 ..... 109



SV-P700 ..... 109



SV-PC20 ..... 110



SV-PC35 ..... 110



SV-PC70 ..... 110



SV-PC75 ..... 110



SV-P400 ..... 110



SV-P398 ..... 112



SV-P500 ..... 112



SV-PP50 ..... 112



SV-M500 ..... 112



SV-M150 ..... 114



SV-M350 ..... 114



SV-M200 ..... 114



SV-M335 ..... 115



EQ-M802 ..... 115



SV-M600 ..... 115



SV-MC15 ..... 116



SV-MC20 ..... 116



































































SV-MC35 ..... 116



SV-M400 ..... 116

# INDICE

## JANDEL EQUAL





				
EQ-M800..... 118	SV-495..... 124	SV-CCDC..... 127	SV-A401..... 129	BH-90RI..... 131
				
EQ-M810..... 118	EQ-1197..... 124	SV-KITC..... 127	PH-100D (DER)... 130	BI-90CD (DER)... 131
				
EQ-M831..... 118	SV-BC15..... 125	KITC20..... 127	PH-100I (IZO) .... 130	BI-90CI..... 131
				
NEW EQ-M861..... 118	SV-BC25..... 125	PICOLORO..... 127	PH-95D (DER) ... 130	BI-80CD (DER) .. 131
				
SV-M360..... 121	SV-B303..... 125	SV-KITB..... 128	PH-95I (IZO)..... 130	BI-80CI..... 131
				
NEW EQ-M802K..... 121	SV-B308..... 125	SV-KITBC..... 128	PI-100D (DER) ... 130	BI-90RD (DER)... 131
				
SV-C150..... 122	SV-CC35..... 125	PU-47/PU-70... 128	PI-100I (IZO)..... 130	BI-90RD (IZO).... 131
				
SV-PP15..... 122	SV-CC50..... 125	SV-PSMN..... 128	PI-95D (DER)..... 130	NEW SV-PR..... 132
				
SV-MP15..... 122	C902..... 125	MR-2542..... 129	PI-95I (IZO)..... 130	NEW SV-PC..... 132
				<b>ACCESORIOS TÉCNICOS..... 133</b>
EQ-285Z..... 124	SVDEDALC..... 126	MR-3560..... 129	BH-90CD (DER) . 131	
				
SV-BR25..... 124	SVDEDALR..... 126	SV-TOPE..... 129	BH-90CI..... 131	
				
SV-B304..... 124	SV-CCDR..... 126	SV-T150..... 129	BH-80CD (DER) . 131	
				
SV-B305..... 124	SV-KITR..... 126	SV-A150..... 129	BH-80CI..... 131	
				
SV-CR50..... 124	KITR20..... 126	SV-T401..... 129	BH-90RD..... 131	

# JANDEL INOX

				
SV-R302..... 135	SV-X338..... 137	SV-M318..... 140	EQ-M810..... 146	SV-B303..... 149
				
SV-X302..... 135	SV-G338..... 137	SV-M338..... 140	EQ-M831..... 146	SV-B308..... 149
				
SV-G302..... 135	SV-P338..... 137	SV-M258..... 140	EQ-M801..... 147	SV-B306..... 149
				
SV-F302..... 135	SV-P339..... 137	SV-M365..... 140	EQ-M802..... 147	SV-1198..... 149
				
SV-E302..... 135	SV-R318 / SV-R358... 138	SV-M360..... 140	EQ-M802K..... 147	HUELLA15..... 149
				
SV-P301..... 135	SV-P318..... 138	SV-MP32..... 141	SV-340..... 148	HUELLA20..... 149
				
SV-P302..... 135	SV-P319..... 138	SV-PP32..... 141	SV-345..... 148	TOPE INOX..... 149
				
SV-R336..... 136	SV-C334..... 138	SV-LP30..... 141	SV-348..... 148	SV-8510..... 150
				
SV-X336..... 136	SV-P334..... 138	SV-MF32..... 141	SV-B304..... 148	EQ-8610..... 150
				
SV-G336..... 136	SV-R258..... 139	SV-LF30..... 141	SV-B305..... 148	SV-170P..... 151
				
SV-F336..... 136	SV-P258..... 139	EQ-M861..... 142	SV-B307..... 148	SV-172P..... 151
				
SV-P336..... 136	SV-C413..... 139	EQ-M851..... 144	SV-B309..... 148	
				
SV-P337..... 136	SV-P413..... 139	EQ-M841..... 145	SV-346..... 149	
				
SV-R338..... 137	SV-M302..... 140	EQ-M800..... 146	SV-347..... 149	

# INDICE

## JANDEL TIRADORES

			
M04A ..... 152	M24/A/B/C ..... 154	H112 ..... 158	H132 ..... 161
			
M26A/B ..... 152	M25A ..... 154	H115 ..... 158	H133 ..... 161
			
M27A ..... 152	M29A ..... 154	H120 ..... 158	H134 ..... 161
			
M28A ..... 152	H55A/B ..... 156	H121 ..... 158	H135 ..... 161
			
M03A ..... 152	H76A ..... 156	H122 ..... 158	H136 ..... 162
			
M07A ..... 152	H93A/B ..... 156	H123 ..... 159	H137 ..... 162
			
M09A/B ..... 152	H94A ..... 156	H124 ..... 159	H138 ..... 162
			
M10A/B ..... 153	H95A/B ..... 156	H125 ..... 159	H140 ..... 162
			
M11A/B ..... 153	H102 ..... 156	H126 ..... 160	SV-HUELLA ... 162
			
M12A/B/C ..... 153	H103 ..... 156	H127 ..... 160	
			
M13A/B/C ..... 153	H113 ..... 156	H128 ..... 160	
			
M14A/B/C/D ..... 153	H107 ..... 158	H129 ..... 161	
			
M22A/B/C ..... 154	H108 ..... 158	H130 ..... 161	
			
M23A/B/C/D/E/F/ G/H/I/J/K/L/M ..... 154	H111 ..... 158	H131 ..... 161	

## LEYENDA DE MATERIALES

LAT Latón  
AL Aluminio  
ZK Zamak  
INOX Inox

## LEYENDA DE ACABADOS



**AN** Anticato



**AN.PL** Anodizado Plata



**ANTR** Antracita

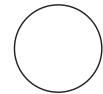

**BL** Blanco



**CB** Cromo Brillo



**CC** Cromo Combinado



**CI** Cuero Inglés



**CO.ST** Cobre Satinado



**CS** Cromo Satinado



**CU** Cuero



**EFCS** Efecto Cromo Satinado



**EFLM** Efecto Latón Mate



**INOX**



**LM** Latón Mate



**MR** Marrón



**NE** Negro



**NM** Níquel Mate



**NM.OP** Níquel Mate Opaco



**NMM** Níquel Mate Mate



**NS** Níquel Satinado



**NS/NB** Níq. Satin./Níq. Brillo



**PB** Pulido Brillo



**PL** Plata



**PS** Pulido Satinado









**PVLM** PVD Latón Mate



NEW







### 1301 Plana ZK

Opciones	Ref.	ANTR	CB	CI	CS	NE	NM		
Ø50  5 	<b>1301</b>	45.03	53.64	53.28	43.92	43.20	46.80	1	16
247  45 	<b>2301</b>	87.48	104.40	84.60	82.80	86.40	87.84	1	12







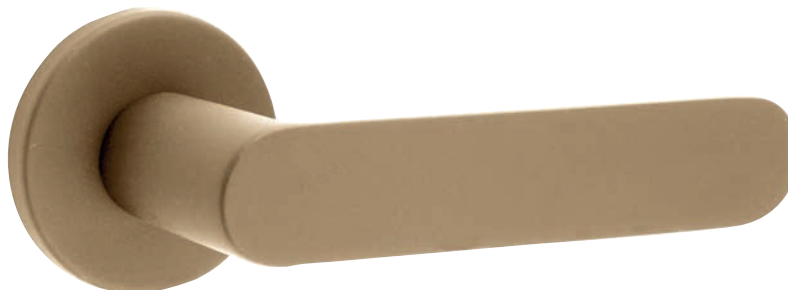

NEW

### 1311 Cloe LAT

Opciones	Ref.	CB	CS	NE	PB		
Ø50  5 	<b>1311</b>	91.80	87.12	88.92	87.12	1	16
247  45 	<b>2311</b>	131.40	117.02	124.20	122.40	1	12



### 1320 Shape AL







Opciones	Ref.	ANTR	BL	CO.ST	EFCS	EFLM	NE	NM.OP		
Ø50  5 	<b>1320</b>	34.92	31.40	34.92	34.92	34.92	31.40	34.92	1	24
247  45 	<b>2320</b>	69.39	79.20	69.39	69.39	71.65	63.62	69.39	1	12





NEW

1327 Corsa ZK

Opciones	Ref.	ANTR	BL	CB	CS	NE	NM	NM.OP		
Ø50  5 	<b>1327</b>	46.05	48.24	59.22	43.92	47.09	47.09	47.16	1	16
247  45 	<b>2327</b>	90.03	91.80	106.92	84.60	88.56	90.03	88.56	1	12



-  AN. PL Anodizado Plata
-  CB Cromo Brillo
-  CU Cuero
-  EFLM Efect. Latón Mate
-  NM Níq. Mate
-  NE Negro
-  ANTR Antracita
-  CI Cuero Inglés
-  CS Cromo Satin.
-  INOX
-  NMM Níquel Mate Mate
-  PB Pulido Brillo
-  BL Blanco
-  CO.ST Cobre Satin.
-  EFCS Efect. Cromo Satin.
-  LM Latón Mate
-  NMOP Níquel Mat. Opaco
-  PL Plata



**1348 Marina New** ZK

Opciones	Ref.	CB	PL		
Ø50 5	<b>1348</b>	61.53	73.44	1	16
247 45	<b>2348</b>	110.52	113.40	1	12



**1356 Easy** ZK

Opciones	Ref.	CB	CI	CS	NM		
Ø50 5	<b>1356</b>	58.50	50.42	41.70	44.12	1	16
247 45	<b>2356</b>	106.20	100.80	74.57	79.20	1	12



**1358 Altwien** LAT

Opciones	Ref.	CB	PB		
Ø50 5	<b>1358</b>	67.18	61.86	1	16
247 45	<b>2358</b>	111.60	85.44	1	12



**1366 Olanda** INOX

Opciones	Ref.	ANTR	BL	CB	EFLM	INOX	NE		
Ø50  5	<b>1366</b>	37.78	37.77	41.15	37.67	36.08	37.77	1	24
247  45	<b>2366</b>	81.02	72.29	71.40	81.02	75.60	68.37	1	12



NEW

**1369 Marion** LAT

Opciones	Ref.	CB	CI	LM	NE	NM	PB		
Ø50  5	<b>1369</b>	103.97	88.31	117.36	91.48	105.63	96.89	1	16
247  45	<b>2369</b>	142.20	138.60	133.20	129.60	140.76	133.20	1	12



NEW





**1379 Inés** LAT

Opciones	Ref.	BL	CB	CI	CS	LM	NE	NM	PB		
Ø50  5	<b>1379</b>	100.80	93.24	89.64	93.24	97.20	83.88	101.88	88.20	1	16
247  45	<b>2379</b>	144.01	140.40	118.80	122.40	118.80	127.80	129.60	135.02	1	12

- AN. PL Anodizado Plata
- ANTR Antracita
- BL Blanco
- CB Cromo Brillo
- CI Cuero Inglés
- CO.ST Cobre Satin.
- CU Cuero
- CS Cromo Satin.
- EFCS Efect. Cromo Satin.
- EFLM Efect. Latón Mate
- INOX
- LM Latón Mate
- NM Níq. Mate
- NMM Níquel Mate Mate
- NMOP Níquel Mat. Opaco
- NE Negro
- PB Pulido Brillo
- PL Plata







### 1388 Ice ZK

Opciones	Ref.	ANTR	BL	CB	CI	CS	NE	NM	NM.OP		
Ø50  5 	<b>1388</b>	44.57	45.88	52.92	55.19	43.35	41.30	45.65	44.57	1	16
247  45	<b>2388</b>	90.02	94.68	104.40	97.20	84.60	86.40	92.88	90.02	1	12







### 1397 Adelle ZK

Opciones	Ref.	CB	CI	CS	NE	NM		
Ø50  5 	<b>1397</b>	60.02	56.78	49.08	48.60	57.17	1	16
247  45	<b>2397</b>	115.20	97.92	90.02	93.60	87.34	1	12



### 1398 Slim ZK

Opciones	Ref.	ANTR	BL	CB	CS	NE	NM	NM.OP		
Ø50  5 	<b>1398</b>	48.04	51.84	52.40	45.87	45.87	48.04	48.04	1	16
247  45	<b>2398</b>	87.34	88.20	102.60	87.34	78.63	79.20	92.16	1	12



NEW

1399 Punto ZK

Opciones	Ref.	ANTR	CB	CS	NE	NM		
Ø50  5	<b>1399</b>	52.56	68.04	51.12	51.48	57.60	1	16
247  45	<b>2399</b>	97.20	115.20	90.02	94.68	96.12	1	12



NEW

3310 Origami ZK

Opciones	Ref.	ANTR	BL	CB	CS	NE	NM		
50X50  5	<b>3310</b>	57.60	64.80	74.52	58.68	57.60	66.96	1	16
248  40	<b>4310</b>	81.03	84.60	106.20	81.72	83.52	84.60	1	12









3327 Corsa ZK

Opciones	Ref.	ANTR	BL	CB	CS	NE	NM	NM.OP		
50X50  5	<b>3327</b>	41.69	41.69	51.05	41.22	41.69	44.18	42.09	1	16
248  40	<b>4327</b>	54.40	72.98	78.20	57.90	51.60	59.55	54.40	1	12

- AN. PL Anodida de Plata
- ANTR Antracita
- BL Blanco
- CB Cromo Brillo
- CI Cuero Inglés
- CO.ST Cobre Satin.
- CU Cuero
- CS Cromo Satin.
- EFCS Efect. Cromo Satin.
- EFLM Efect. Latón Mate
- INOX
- LM Latón Mate
- NM Níq. Mate
- NMM Níquel Mate Mate
- NMOP Níquel Mat. Opaco
- NE Negro
- PB Pulido Brillo
- PL Plata









### 3337 Viper ZK

Opciones	Ref.	BL	CB	CI	CS	NE	NM		
50X50  5 	<b>3337</b>	60.48	60.71	82.53	58.50	56.09	59.84	1	16
248  40 	<b>4337</b>	93.60	87.10	106.20	75.10	70.35	79.32	1	12









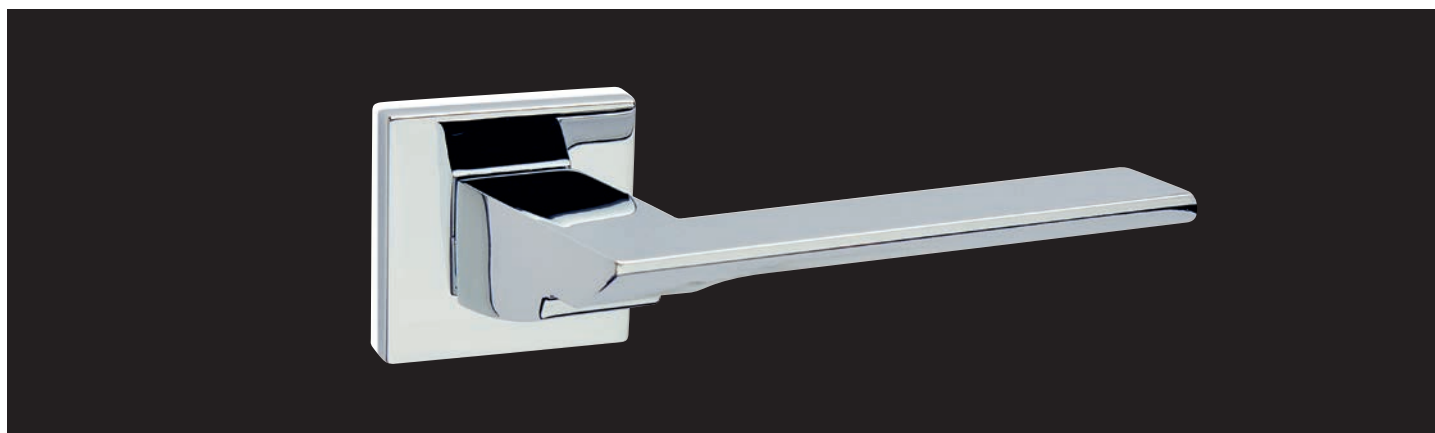

**3357 Flak** ZK

Opciones	Ref.	ANTR	CB	CI	NE	NM	NM.OP		
50X50  5 	<b>3357</b>	41.69	51.05	55.19	41.69	40.90	41.69	1	16
248  40 	<b>4357</b>	72.02	87.48	73.44	70.20	72.02	54.40	1	12









**3367 Italia** ZK

Opciones	Ref.	ANTR	BL	CB	CS	NE		
50X50  5 	<b>3367</b>	41.69	45.04	51.05	41.22	40.58	1	16
248  40 	<b>4367</b>	72.02	73.80	87.48	69.12	70.20	1	12







**3377 Pura** ZK

Opciones	Ref.	ANTR	BL	CB	CS	NE	NM.OP		
50X50  5 	<b>3377</b>	41.69	45.04	51.05	41.22	40.58	41.69	1	16
248  40 	<b>4377</b>	72.02	73.80	87.48	69.12	70.20	72.02	1	12

-  AN. PL Anodizado Plata
-  CB Cromo Brillo
-  CU Cuero
-  EFLM Efect. Latón Mate
-  NM Níq. Mate
-  NE Negro
-  ANTR Antracita
-  CI Cuero Inglés
-  CS Cromo Satin.
-  INOX
-  NMM Níquel Mate Mate
-  PB Pulido Brillo
-  BL Blanco
-  CO.ST Cobre Satin.
-  EFCS Efect. Cromo Satin.
-  LM Latón Mate
-  NMOP Níquel Mat. Opaco
-  PL Plata



### 3378 Swarogk i LAT

Opciones	Ref.	CB		
50X50  5 	<b>3378</b>	141.38	1	16
248  40	<b>4378</b>	180.88	1	12

Con cristal de Swarovski





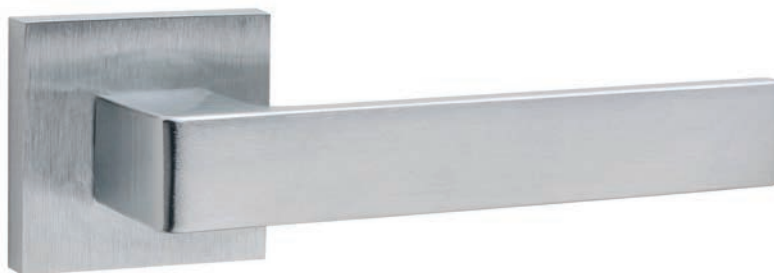

3388 Ice ZK

Opciones	Ref.	ANTR	BL	CB	CI	CS	NE	NM	NM.OP		
50x50  5	3388	46.30	47.17	54.26	55.59	45.04	43.68	46.30	46.30	1	16
248  40	4388	67.31	75.60	83.88	81.02	69.12	59.94	75.60	73.80	1	12



3398 Slim ZK

Opciones	Ref.	ANTR	BL	CB	CS	NE	NM	NM.OP		
50x50  5	3398	57.19	57.19	55.44	48.04	48.04	50.22	50.22	1	16
248  40	4398	75.60	79.20	82.80	72.00	73.08	75.60	75.60	1	12









3720 Shape AL

Opciones	Ref.	ANTR	BL	CO.ST	EFCS	EFLM	NE	NM.OP		
Ø25  2	3720	27.90	23.51	34.28	27.90	27.90	23.51	27.90	1	24
247  45	2320	69.39	79.20	69.39	69.39	71.65	63.62	69.39	1	12

- AN. PL Anodizado Plata
- CB Cromo Brillo
- CU Cuero
- EFLM Efect. Latón Mate
- NM Níq. Mate
- NE Negro
- ANTR Antracita
- CI Cuero Inglés
- CS Cromo Satin.
- INOX
- NMM Níquel Mate Mate
- PB Pulido Brillo
- BL Blanco
- CO.ST Cobre Satin.
- EFCS Efect. Cromo Satin.
- LM Latón Mate
- NMOP Níquel Mat. Opaco
- PL Plata







### 3766 Olanda INOX

Opciones	Ref.	BL	CB	INOX	NE		
Ø25  2 	<b>3766</b>	36.69	30.60	25.64	31.43	1	24
247  45 	<b>2366</b>	72.29	71.40	75.60	68.37	1	12





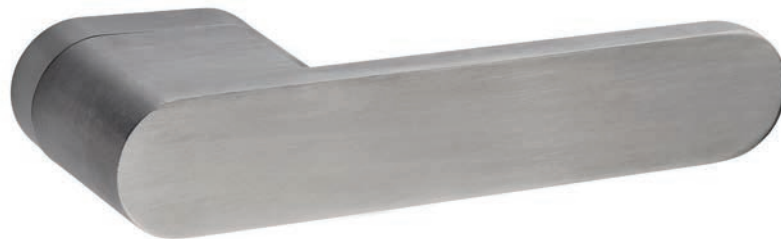

### 3887 Infinity ZK

Opciones	Ref.	CS	NE		
52X35  10 	<b>3887</b>	111.93	111.93	1	16



NEW

### 3889 Futura AL

Opciones	Ref.	AN.PL	NE		
52X35  10 	<b>3889</b>	198.03	198.03	1	16



**3976 Kubo** AL

Opciones	Ref.	ANTR	BL	EFCS	NE	NM.OP		
25X25 2	<b>3976</b>	34.74	31.22	34.74	31.22	34.74	1	24
248 40	<b>4376</b>	68.40	67.68	68.40	53.82	63.98	1	12



**6318 u liette** LAT

Opciones	Ref.	CI	PB	PL		
Ø50 10	<b>6318</b>	74.06	75.24	77.22	1	16
247 45	<b>2318</b>	106.92	106.92	104.55	1	12







**6328 Vittoria** LAT

Opciones	Ref.	CI	NE	PL		
Ø50 10	<b>6328</b>	76.83	77.22	86.73	1	16
247 45	<b>2328</b>	100.80	84.95	119.88	1	12

- AN. PL Anodido Plata
- CB Cromo Brillo
- CU Cuero
- EFLM Efect. Latón Mate
- NM Níq. Mate
- NE Negro
- ANTR Antracita
- CI Cuero Inglés
- CS Cromo Satin.
- INOX
- NMM Níquel Mate Mate
- PB Pulido Brillo
- BL Blanco
- CO.ST Cobre Satin.
- EFCS Efect. Cromo Satin.
- LM Latón Mate
- NMOP Níquel Mat. Opaco
- PL Plata







**6338 Rodi** LAT

Opciones	Ref.	CB	PB		
Ø50  10 	<b>6338</b>	111.68	111.68	1	16
247  45	<b>2338</b>	193.54	193.54	1	12



**6347 Calliope** ZK

Opciones	Ref.	CB	CI	CS	NM	PB	PL		
Ø50  10 	<b>6347</b>	41.69	45.43	37.91	44.57	45.04	64.26	1	16
247  45	<b>2347</b>	82.98	79.02	75.60	79.20	81.66	104.55	1	12

Estas referencias se pueden montar con todas las manivelas y en todos los acabados de nuestra serie **Jandel Premium**

## PLACAS

### 23 LAT

Placa manivela



### 43 LAT

Placa manivela



### 00 LAT

Placa manivela sin muelle



## ROSETAS

### CXC

60 x 30 x 10 mm  
Roseta rect.  
Con muelle



### CX

60 x 30 x 10 mm  
Roseta oval  
Con muelle



## GRISÁN

### GC

64 x 30 x 10 mm  
Placa grisán  
DK rectangular



### G

64 x 30 x 10 mm  
Placa grisán  
DK oval



Ref.	ANTR	BL	CB	CI	CO.ST	CS	EFCS	EFLM	INOX	LM	NE	NM	NM.OP	PB	PL
<b>23</b>	16.64	15.53	17.73	19.83	16.64	17.09	16.64	19.20	-	19.52	15.53	16.64	16.64	20.16	23.68
<b>43</b>	12.80	12.80	19.24	16.96	-	11.65	12.80	-	-	-	11.65	13.60	12.80	-	-
<b>00</b>	14.12	13.44	13.60	13.12	14.12	13.60	14.12	14.12	-	12.68	14.44	14.44	14.12	12.48	18.56
<b>GC</b>	12.48	11.52	12.32	12.48	-	12.32	12.48	-	-	-	11.52	12.80	12.48	-	-
<b>G</b>	10.56	9.28	10.40	10.56	10.56	10.40	10.56	10.56	9.92	9.92	12.39	10.88	10.56	9.92	15.33
<b>CXC</b>	16.64	15.68	16.48	16.64	-	16.48	16.64	-	-	-	15.68	17.12	16.64	-	-
<b>CX</b>	11.20	10.24	11.04	11.20	11.20	11.04	11.20	11.20	10.56	10.56	10.44	11.68	11.20	10.56	16.32

- AN. PL Anodizado Plata
- CB Cromo Brillo
- CU Cuero
- EFLM Efect. Latón Mate
- NM Níq. Mate
- NE Negro
- ANTR Antracita
- CI Cuero Inglés
- CS Cromo Satin.
- INOX
- NMM Níquel Mate Mate
- PB Pulido Brillo
- BL Blanco
- CO.ST Cobre Satin.
- EFCS Efect. Cromo Satin.
- LM Latón Mate
- NMOP Níquel Mat. Opaco
- PL Plata



Ref.	BL	CB	INOX	NE	
<b>CG66</b> INOX	19.20	21.12	17.28	17.64	1



Ref.	ANTR	BL	CO.ST	EFC5	EFLM	NE	NM.OP	
<b>CG20</b> AL	16.20	15.49	20.00	20.00	16.20	15.49	16.20	1

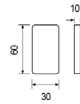

Ref.	ANTR	BL	CB	CI	CS	NE	NM	NM.OP	
<b>G88C</b> ZK	24.64	26.08	26.88	25.60	23.36	23.68	25.60	24.64	1



Ref.	mm (entre cent.)	BL	CB	INOX	NE	
<b>EQ-M802</b> INOX	Ø25 (200)	57.60	64.45	26.95	29.03	2



Ref.	mm (entre cent.)	BL	CB	CO.ST	CS	EFLM	NE	NMM	
<b>C349</b> ZK	200	20.16	20.16	39.47	19.56	39.47	20.16	19.56	2

Ref.	mm (entre cent.)	ANTR	BL	CB	CI	CO.ST	CS	EFLM	LM	NE	NM	NMM	PB	
<b>C327</b> ZK	<b>210</b>	21.75	21.75	20.68	20.68	39.92	20.68	39.92	20.68	22.03	20.68	21.24	20.68	2

- AN. PL Anodizado Plata
- CB Cromo Brillo
- CU Cuero
- EFLM Efect. Latón Mate
- NM Níq. Mate
- NE Negro
- ANTR Antracita
- CI Cuero Inglés
- CS Cromo Satin.
- INOX
- NMM Níquel Mate Mate
- PB Pulido Brillo
- BL Blanco
- CO.ST Cobre Satin.
- EFCS Efect. Cromo Satin.
- LM Latón Mate
- NMOP Níquel Mat. Opaco
- PL Plata

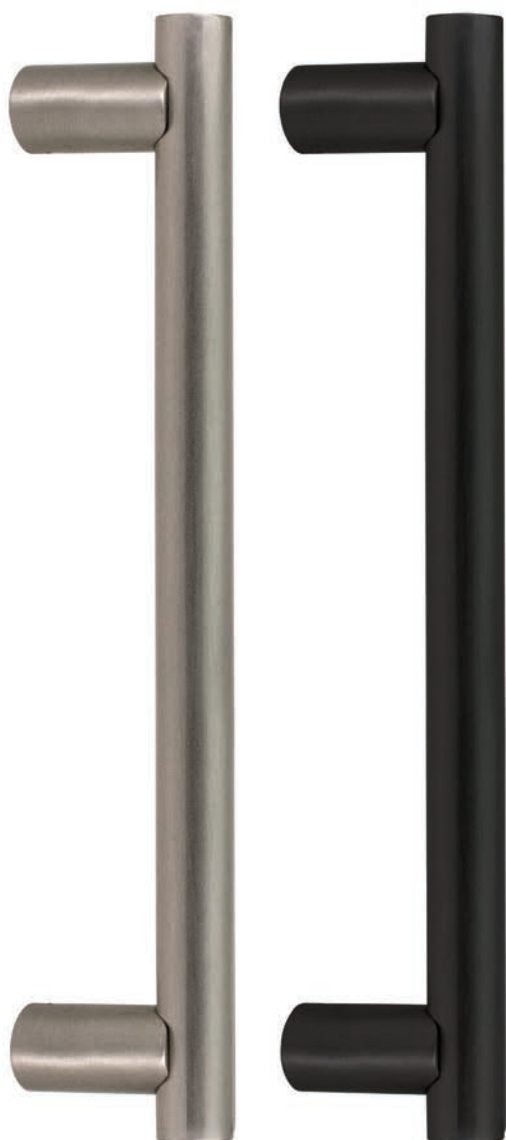

NEW

Ref.	mm (entre cent.)	BL	CB	CI	CS	LM	NE	NM	PB	
C379 LAT	Ø20 (250)	107.20	100.80	92.80	92.80	92.80	80.02	100.80	99.20	1

NEW

Ref.	mm (entre cent.)	CB	CI	LM	NE	NM	PB	
C369 LAT	Ø22 (300)	235.84	235.84	232.32	211.20	235.84	232.32	1





NEW

Ref.	mm (entre cent.)	CB	PL	
C348 ZK	210	118.08	121.60	1



NEW

Ref.	mm (entre cent.)	CB	PB	
C338 LAT	265	140.80	137.60	1

- AN. PL Anodizado Plata
- CB Cromo Brillo
- CU Cuero
- EFLM Efect. Latón Mate
- NM Níq. Mate
- NE Negro
- ANTR Antracita
- CI Cuero Inglés
- CS Cromo Satin.
- INOX
- NMM Níquel Mate Mate
- PB Pulido Brillo
- BL Blanco
- CO.ST Cobre Satin.
- EFCS Efect. Cromo Satin.
- LM Latón Mate
- NMOP Níquel Mat. Opaco
- PL Plata

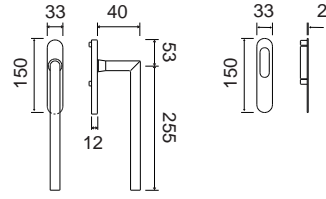

NEW

Ref.	ANTR	BL	INOX	NE	
<b>102AL2</b> INOX	75.84	75.84	63.36	72.02	2

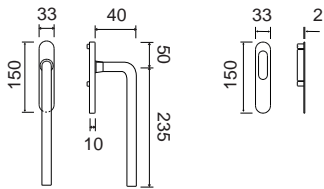

NEW

Ref.	AN	CB	CI	CS	NE	NM	PB	
<b>359AL2</b> LAT	163.47	178.34	163.47	178.34	188.20	153.53	153.53	2



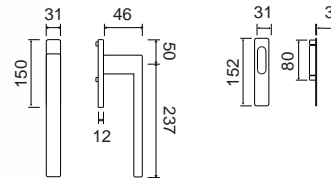

NEW

Ref.	ANTR	BL	CS	NE	
<b>168AL2</b> ZK	144.02	147.20	134.40	137.60	2



- AN. PL Anodizado Plata
- CB Cromo Brillo
- CU Cuero
- EFLM Efect. Latón Mate
- NM Níq. Mate
- NE Negro
- ANTR Antracita
- CI Cuero Inglés
- CS Cromo Satin.
- INOX
- NMM Níquel Mate Mate
- PB Pulido Brillo
- BL Blanco
- CO.ST Cobre Satin.
- EFCS Efect. Cromo Satin.
- LM Latón Mate
- NMOP Níquel Mat. Opaco
- PL Plata

### Serie 13 roseta Ø50x5 mm



### Bocallas ZK

Ref.	ANTR	BL	CB	CI	CO.ST	CS	EFCS	EFLM	INOX	LM	NE	NM	NM.OP	PB	PL	
<b>13BY</b>	5.09	5.46	3.89	3.89	5.46	3.83	5.09	6.47	4.29	4.63	5.09	5.09	5.09	4.63	8.69	10
<b>13BO</b>	5.09	5.46	3.89	3.89	5.46	3.83	5.09	6.47	4.29	4.63	5.09	5.09	5.09	4.63	8.69	10



### Condenas ZK

Ref.	ANTR	BL	CB	CI	CO.ST	CS	EFCS	EFLM	INOX	LM	NE	NM	NM.OP	PB	PL	
<b>13WC</b>	22.37	23.11	19.22	19.59	25.51	19.17	22.37	25.51	19.84	20.71	22.37	25.51	22.37	20.71	31.05	5



NEW

### Condenas LAT

Ref.	CB	CI	LM	NE	NM	PB	
<b>MARIONWC</b>	26.88	26.88	28.90	27.56	27.56	26.18	5

**Serie 33 roseta 50x50x5 mm**



**Bocallas ZK**

Ref.	ANTR	BL	CB	CI	CS	NE	NM	NM.OP	
<b>33BY</b>	5.84	6.18	5.57	5.75	4.42	5.30	5.30	6.18	10
<b>33BO</b>	5.84	6.18	5.57	5.75	4.42	5.30	5.30	6.18	10



**Condenas ZK**

Ref.	ANTR	BL	CB	CI	CS	NE	NM	NM.OP	
<b>33WC</b>	24.36	25.41	23.30	32.84	20.84	23.65	22.76	26.47	5

**Serie 37 roseta Ø25x2 mm**



**Bocallas ZK**

Ref.	mm	ANTR	BL	CB	CO.ST	EFCS	EFLM	NE	NM.OP	
<b>37BY</b>	40x25x2	14.98	15.33	14.98	16.58	16.26	16.26	14.80	14.98	10
<b>37BO</b>	25x2	4.77	5.12	4.77	6.37	6.05	6.05	4.77	4.80	10



**Condenas LAT**

Ref.	ANTR	BL	CB	CO.ST	EFCS	EFLM	INOX	NE	NM.OP	
<b>37WC</b>	21.02	21.19	20.52	25.22	21.02	21.02	23.68	18.60	21.02	5

- AN. PL Anodizado Plata
- CB Cromo Brillo
- CU Cuero
- EFLM Efect. Latón Mate
- NM Níq. Mate
- NE Negro
- ANTR Antracita
- CI Cuero Inglés
- CS Cromo Satin.
- INOX
- NMM Níquel Mate Mate
- PB Pulido Brillo
- BL Blanco
- CO.ST Cobre Satin.
- EFCS Efect. Cromo Satin.
- LM Latón Mate
- NMOP Níquel Mat. Opaco
- PL Plata

**Serie 38 roseta 52x40x10 mm**



**Bocallae s ZK**

Ref.	CS	NE	
<b>38BY</b>	7.06	7.06	10
<b>38BO</b>	7.06	7.06	10



**Condenas LAT**

Ref.	CS	NE	
<b>38WC</b>	26.12	27.17	5

**Serie 39 roseta 25x25x2 mm**

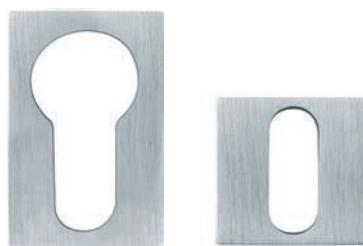

**Bocallae s ZK**

Ref.	mm	ANTR	BL	EFCS	NE	NM.OP	
<b>39BY</b>	40x25x2	14.98	15.33	16.26	14.98	15.99	10
<b>39BO</b>	25x25x2	5.35	5.46	6.63	4.34	5.35	10



**Condenas LAT**

Ref.	ANTR	BL	EFCS	NE	NM.OP	
<b>39WC</b>	24.03	22.95	24.03	20.68	24.03	5

**Serie 63 roseta Ø50x10 mm**



**Bocallas LAT**

Ref.	CB	CI	CS	NE	NM	PB	PL	
<b>63BY</b>	8.76	9.16	8.76	8.32	8.95	8.76	11.40	10
<b>63BO</b>	8.76	9.16	8.76	8.32	8.95	8.76	11.40	10



**Condenas LAT**

Ref.	CB	CI	CS	NE	NM	PB	PL	
<b>63WC</b>	30.92	32.11	35.40	28.32	32.53	30.21	39.04	5

**Roseta 35 mm**



**Condenas roseta Ø35x7 mm LAT**

Ref.	ANTR	BL	CB	CI	CO.ST	CS	EFCS	EFLM	LM	NE	NM	NM.OP	PB	PL	
<b>01WC</b>	25.29	29.57	29.57	31.43	25.89	21.04	25.29	25.29	25.89	25.29	31.43	25.29	25.89	32.61	5



**Condenas roseta 35x35x7 mm LAT**

Ref.	ANTR	BL	CB	CI	CS	NE	NM	NM.OP	
<b>03WC</b>	29.54	33.23	26.60	33.28	25.84	29.54	29.54	29.54	5

- AN. PL Anodizado Plata
- CB Cromo Brillo
- CU Cuero
- EFLM Efect. Latón Mate
- NM Níq. Mate
- NE Negro
- ANTR Antracita
- CI Cuero Inglés
- CS Cromo Satin.
- INOX
- NMM Níquel Mate Mate
- PB Pulido Brillo
- BL Blanco
- CO.ST Cobre Satin.
- EFCS Efect. Cromo Satin.
- LM Latón Mate
- NMOP Níquel Mat. Opaco
- PL Plata

### Roseta oval 60x30x10 mm

NEW



**CXBY** ZK

Ref.	ANTR	BL	CB	CI	CO.ST	CS	EFCS	EFLM	NE	NM	NM.OP	PB	PL	
<b>CXBY</b>	10.40	9.41	8.64	8.01	10.40	8.64	10.40	10.40	9.41	9.28	10.40	8.01	12.80	10

NEW



**CXBO** ZK

Ref.	ANTR	BL	CB	CI	CO.ST	CS	EFCS	EFLM	NE	NM	NM.OP	PB	PL	
<b>CXBO</b>	10.40	9.41	8.64	8.01	10.40	8.64	10.40	10.40	9.41	9.28	10.40	8.01	12.80	10

### Roseta rectangular 60x30x10 mm

NEW



**CXBYC** ZK

Ref.	ANTR	BL	CB	CI	CO.ST	CS	EFCS	EFLM	NE	NM	NM.OP	PB	PL	
<b>CXBYC</b>	10.88	9.92	10.56	10.24	10.88	10.56	10.88	10.88	9.92	11.68	10.88	9.92	17.60	10

NEW



**CXBOC** ZK

Ref.	ANTR	BL	CB	CI	CO.ST	CS	EFCS	EFLM	NE	NM	NM.OP	PB	PL	
<b>CXBOC</b>	10.88	9.92	10.56	10.24	10.88	10.56	10.88	10.88	9.92	11.68	10.88	9.92	17.60	10



**Bocallaves de seguridad (puerta de entrada)**



**C630 roseta Ø50x10 mm (seguridad) LAT**

Ref.	ANTR	BL	CB	CI	CS	LM	NE	NM	NMM	PB	PL	
<b>C630</b>	6.96	8.29	8.29	8.29	8.29	8.29	8.29	8.29	6.96	8.29	6.96	10



**C635 roseta 50x50x10 mm (seguridad) LAT**

Ref.	ANTR	BL	CB	CI	CS	LM	NE	NM	NMM	PB	
<b>C635</b>	7.43	8.29	8.29	7.43	8.29	7.43	8.29	8.29	7.43	7.43	10

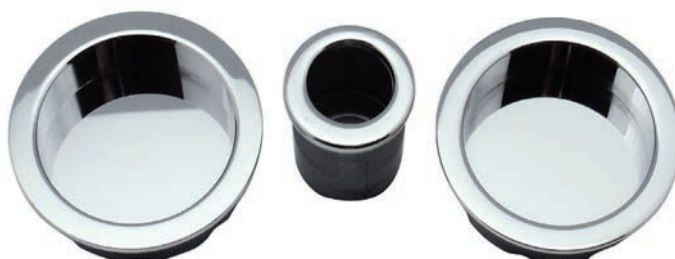

**Kit redondo Ø56 mm (Ø48 interior) LAT**

Ref.	ANTR	BL	CB	CI	CO.ST	CS	EFLM	LM	NE	NM	NM.OP	PB	PL	
<b>7610</b>	19.59	18.50	21.45	21.73	22.18	21.45	23.52	23.57	18.50	22.47	22.18	22.24	42.85	1

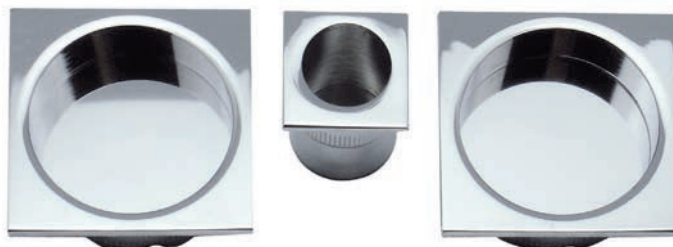

**Kit cuadrado 56x56 mm (Ø48 interior) LAT**

Ref.	ANTR	BL	CB	CI	CS	LM	NE	NM	NM.OP	PB	
<b>7630</b>	20.90	19.20	26.12	24.71	26.12	27.11	19.22	34.08	24.04	26.43	1

- AN. PL Anodizado Plata
- CB Cromo Brillo
- CU Cuero
- EFLM Efect. Latón Mate
- NM Níq. Mate
- NE Negro
- ANTR Antracita
- CI Cuero Inglés
- CS Cromo Satin.
- INOX
- NMM Níquel Mate Mate
- PB Pulido Brillo
- BL Blanco
- CO.ST Cobre Satin.
- EFCS Efect. Cromo Satin.
- LM Latón Mate
- NMOP Níquel Mat. Opaco
- PL Plata

Ref. 75220 LAT

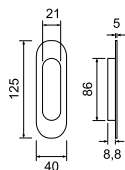

Ref. 75200 LAT

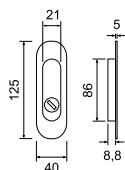

Ref. 75420 LAT

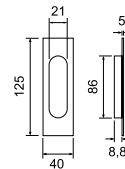

Ref. 75400 LAT

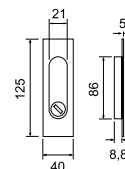

Opciones	Ref.	ANTR	BL	CB	CI	CS	CU	LM	NE	NM	NM.OP	PB	
125-40	<b>7.5220</b>	22.18	22.85	24.40	23.66	24.40	24.04	22.99	23.40	27.36	22.18	22.99	1
125-40	<b>7.5200</b>	51.01	52.49	54.92	53.60	54.92	50.64	49.54	49.90	54.92	51.01	49.54	1
125-40	<b>7.5420</b>	24.04	24.40	25.73	25.89	25.73	25.89	23.30	23.66	25.89	24.04	23.30	1
125-40	<b>7.5400</b>	51.75	53.23	55.46	51.75	55.46	51.75	50.64	51.01	54.92	51.75	50.64	1

Kits correderas



Kit redondo c/condena Ø56 mm (Ø48 interior) ZK

Ref.	BL	CB	CS	CU	LM	NE	NM	PB	
9510	34.82	34.82	34.82	34.82	34.82	34.82	34.82	34.82	1

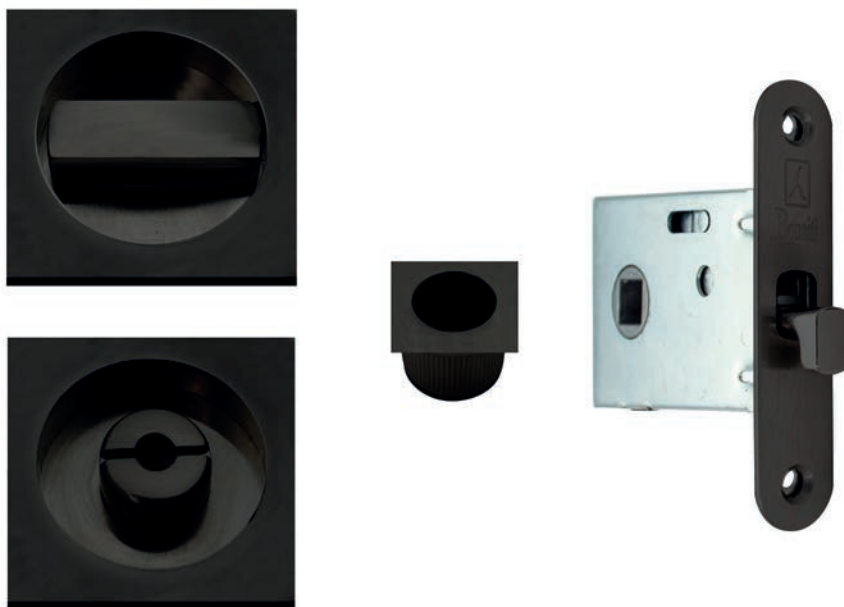

Kit cuadrado c/condena 56x56 mm (Ø48 interior) ZK

Ref.	BL	CB	CS	LM	NE	NM	PB	
9530	34.82	34.82	34.82	34.82	34.82	34.82	34.82	1

- AN. PL Anodizado Plata
- CB Cromo Brillo
- CU Cuero
- EFLM Efect. Latón Mate
- NM Níquel Mate
- NE Negro
- ANTR Antracita
- CI Cuero Inglés
- CS Cromo Satin.
- INOX
- NMM Níquel Mate Mate
- PB Pulido Brillo
- BL Blanco
- CO.ST Cobre Satin.
- EFCS Efect. Cromo Satin.
- LM Latón Mate
- NMOP Níquel Mat. Opaco
- PL Plata



### 1023 Gótica LAT

Opciones	Ref.	CI	PL		
Ø50  10	<b>1023</b>	79.10	109.19	1	20
280  50	<b>8023</b>	95.48	126.02	1	20



### 1045 Flexa LAT

Opciones	Ref.	CI	CS	LM	NM	PB		
Ø50  10	<b>1045</b>	50.58	58.11	50.58	60.95	49.04	1	20
241  42	<b>1545</b>	50.58	58.47	50.58	60.95	49.04	1	20

JANDEL ORIGINAL



### 1059 Air ZK

Opciones	Ref.	AN	CI	NE	PL		
Ø50  10	<b>1059</b>	18.89	18.89	18.89	18.89	1	20
265  48	<b>4459</b>	35.45	34.05	34.54	35.45	1	20



### 1072 Nuri LAT

Opciones	Ref.	CI	CS	LM	NM	PB		
Ø50  10	<b>1072</b>	50.58	58.11	50.58	60.95	54.72	1	20
241  42	<b>1572</b>	50.58	58.11	50.58	60.95	54.72	1	20



### 1075 Corinne LAT

Opciones	Ref.	CI	CU	LM	MR	NM	PB	PL		
Ø50  10	<b>1075</b>	59.04	59.04	28.54	59.04	28.54	28.54	28.54	1	20
241  42	<b>1575</b>	60.52	60.52	48.54	60.52	48.54	48.54	48.54	1	20



### 1080 Pilar LAT

Opciones	Ref.	CC	CI	CS	LM	NM	PB		
Ø50  10	<b>1080</b>	81.40	66.96	81.40	66.96	84.64	65.67	1	20
241  42	<b>1580</b>	81.40	66.96	81.40	66.96	84.64	65.67	1	20



## 1082 Kubic LAT

Opciones	Ref.	CC	CS	LM	NM	PB		
Ø50 10	<b>1082</b>	89.57	89.57	81.65	89.57	81.65	1	20
241 42	<b>1582</b>	89.57	89.57	81.65	89.57	81.65	1	20



## 1090 Marina LAT

Opciones	Ref.	CS	LM	NM		
Ø50 10	<b>1090</b>	64.12	54.98	65.38	1	20
241 42	<b>1590</b>	64.12	54.98	65.38	1	20



## 1092 Tek a ZK

Opciones	Ref.	CS	NM		
Ø50 10	<b>1092</b>	58.58	61.35	1	20
241 42	<b>1592</b>	58.58	61.35	1	20



## 1105 Gaudel LAT

Opciones	Ref.	CI	CS	LM	NM	PB		
Ø50 10	<b>1105</b>	28.64	32.94	28.64	32.94	28.64	1	20
241 42	<b>1605</b>	48.24	55.48	48.24	58.11	46.77	1	20



- AN Anticato
- CB Cromo Brillo
- CS Cromo Satinado
- MR Marrón
- NMM Níquel Mate Mate
- PB Pulido Brillo
- PVLM PVD Lat. Mate
- ANTR Antracita
- CC Cromo Combinado
- CU Cuero
- NE Negro
- NM.OP Níq. Mat. Opaco
- PS Pulido Satin.
- BL Blanco
- CI Cuero Inglés
- LM Latón Mate
- NM Níquel Mate
- NS Níquel Satinado
- PL Plata

JANDEL ORIGINAL



### 1115 Venere LAT

Opciones	Ref.	CB	CI	CS	LM	NM		
Ø50 10	<b>1115</b>	34.96	30.40	34.96	30.40	34.96	1	20
241 42	<b>1615</b>	61.49	53.14	61.49	53.14	63.94	1	20

### 1209 Ea ZK

Opciones	Ref.	ANTR	CB	CS	NE	PVLM		
Ø50 10	<b>1209</b>	24.80	24.34	24.34	24.80	65.18	1	20
241 42	<b>1509</b>	44.80	44.34	44.34	44.80	85.18	1	20

JANDEL ORIGINAL



### 1213 Elle ZK

Opc.	Ref.	ANTR	BL	CB	CI	CS	LM	NE	NM	PVLM		
Ø50 10	<b>1213</b>	24.80	24.34	24.34	24.34	24.34	24.34	24.34	24.34	67.38	1	20
241 42	<b>1513</b>	44.80	44.34	44.34	44.34	44.34	44.34	44.34	44.34	87.38	1	20

### 1219 Laia ZK

Opciones	Ref.	CB	CS	NE	NM		
Ø50 10	<b>1219</b>	24.34	24.34	24.34	24.34	1	20
241 42	<b>1519</b>	44.34	44.34	44.34	44.34	1	20





## 1224 u an ZK

Opciones	Ref.	CB	CS	NM		
Ø50	<b>1224</b>	24.34	24.34	24.34	1	20
241	<b>1524</b>	44.34	44.34	44.34	1	20



## 1229 Dolce ZK

Opciones	Ref.	CB	CS	NE	NMM		
Ø50	<b>1229</b>	26.07	26.07	26.07	26.07	1	20
241	<b>1529</b>	46.07	46.07	46.07	46.07	1	20



## 1234 Virgo ZK

Opciones	Ref.	CB	CS	NE	NM		
Ø50	<b>1234</b>	23.94	23.94	23.94	23.94	1	20
241	<b>1534</b>	43.94	43.94	43.94	43.94	1	20



## 1239 Susi ZK

Opciones	Ref.	CB	CS	NE	NMM		
Ø50	<b>1239</b>	25.56	25.56	25.56	25.56	1	20
241	<b>1539</b>	45.56	45.56	45.56	45.56	1	20



## 1249 Clubb ZK

Opciones	Ref.	ANTR	BL	CB	CI	CS	NE	NMM		
50	<b>1249</b>	23.94	23.94	23.94	23.94	23.94	23.94	23.94	1	20
241	<b>1549</b>	43.94	43.94	43.94	43.94	43.94	43.94	43.94	1	20



## 1254 Aria ZK

Opciones	Ref.	CB	CS	NM		
Ø50	<b>1254</b>	24.34	24.34	24.34	1	20
241	<b>1554</b>	44.34	44.34	44.34	1	20

- AN Anticato
- CB Cromo Brillo
- CS Cromo Satinado
- MR Marrón
- NMM Níquel Mate Mate
- PB Pulido Brillo
- PVLML PVD Lat. Mate
- ANTR Antracita
- CC Cromo Combinado
- CU Cuero
- NE Negro
- NM.OP Niq. Mat. Opaco
- PS Pulido Satin.
- BL Blanco
- CI Cuero Inglés
- LM Latón Mate
- NM Níquel Mate
- NS Níquel Satinado
- PL Plata

JANDEL ORIGINAL



NEW

**12TE** ZK

Opciones	Ref.	BL	CI	LM	NE	NM		
	<b>12TE</b>	33.34	33.34	33.34	33.34	33.34	1	20
	<b>15TE</b>	53.34	53.34	53.34	53.34	53.34	1	20
	<b>WCTE</b>	15.34	15.34	15.34	15.34	15.34	2	40
	<b>HQTE</b>	5.95	5.95	5.95	5.95	5.95	10	200
	<b>H2TE</b>	11.04	11.04	11.04	11.04	11.04	5	100







JANDEL ORIGINAL

- AN Anticato
- ANTR Antracita
- BL Blanco
- CB Cromo Brillo
- CC Cromo Combinado
- CI Cuero Inglés
- CS Cromo Satinado
- CU Cuero
- LM Latón Mate
- MR Marrón
- NE Negro
- NM Níquel Mate
- NMM Níquel Mate Mate
- NM.OP Níq. Mat. Opaco
- NS Níquel Satinado
- PB Pulido Brillo
- PS Pulido Satin.
- PL Plata
- PVLM PVD Lat. Mate



**1264 Heay** ZK

Opciones	Ref.	CB	CS	NM		
Ø50 10	<b>1264</b>	24.34	24.34	24.34	1	20
241 42	<b>1564</b>	44.34	44.34	44.34	1	20



**2040 Línea** LAT

Opciones	Ref.	CS	LM	NM		
Ø50 10	<b>2040</b>	63.36	55.73	65.88	1	20
241 42	<b>2540</b>	63.94	59.04	68.87	1	20



**6042 Polaris** LAT

Opciones	Ref.	CC	CI	CS	CU	LM	NM	PB	PS		
Ø50 10	<b>6042</b>	56.31	46.80	56.31	46.80	46.80	58.86	46.80	46.80	1	20
241 42	<b>1542</b>	56.31	46.80	56.31	46.80	46.80	58.86	46.80	46.80	1	20

**Karol** ZK

Opciones	Ref.	CI	LM	NM	PB		
Ø50 10	<b>KAROL ROSETA</b>	40.83	45.26	55.12	40.83	1	20
241 42	<b>KAROL PLACA</b>	40.83	45.26	55.12	40.83	1	20





**EQ-R207** ZK

Opciones	PB		
Ø50 10	16.67	1	20



**EQ-R208** ZK

Opciones	CU		
Ø50 10	16.67	1	20



**EQ-R209** ZK

Opciones	NM		
Ø50 10	16.67	1	20



**EQ-R450** LAT

Opciones	CU	PB		
Ø50 10	24.60	24.60	1	20

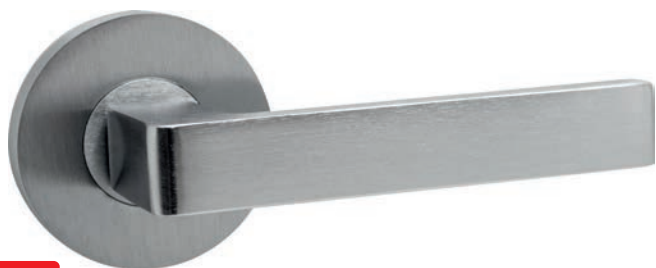

**NEW**

Tapa Pomos

**EQ-R653** ZK

mm	CS	NE	NM		
Ø 65	28.78	28.78	28.78	1	20



**NEW**

Tapa Pomos

**EQ-R657** ZK

mm	CU	NE	NM	PB		
Ø 65	24.34	24.34	24.34	24.34	1	20

- AN Anticato
- CB Cromo Brillo
- CS Cromo Satinado
- MR Marrón
- NMM Níquel Mate Mate
- PB Pulido Brillo
- PVLML PVD Lat. Mate
- ANTR Antracita
- CC Cromo Combinado
- CU Cuero
- NE Negro
- NM.OP Níq. Mat. Opaco
- PS Pulido Satin.
- BL Blanco
- CI Cuero Inglés
- LM Latón Mate
- NM Níquel Mate
- NS Níquel Satinado
- PL Plata

JANDEL ORIGINAL



**EQ-R890** LAT

Opciones	AN	CI	CU	NM	PB	PL		
Ø50 10	37.63	37.63	37.63	37.63	37.63	37.63	1	20

\*Porcelana craquelé



**EQ-R891** LAT

Opciones	AN	CI	CU	NM	PB	PL		
Ø50 10	37.63	37.63	37.63	37.63	37.63	37.63	1	20

\*Porcelana beige



**EQ-R892** LAT

Opciones	AN	CI	CU	NM	PB	PL		
Ø50 10	37.63	37.63	37.63	37.63	37.63	37.63	1	20

\*Porcelana blanca





JANDEL ORIGINAL

- |                  |                      |                     |                  |                         |                    |                       |
|------------------|----------------------|---------------------|------------------|-------------------------|--------------------|-----------------------|
| ● AN Anticato    | ● CB Cromo Brillo    | ● CS Cromo Satinado | ● MR Marrón      | ● NMM Níquel Mate Mate  | ● PB Pulido Brillo | ● PVL M PVD Lat. Mate |
| ● ANTR Antracita | ● CC Cromo Combinado | ● CU Cuero          | ● NE Negro       | ● NM.OP Níq. Mat. Opaco | ● PS Pulido Satin. |                       |
| ○ BL Blanco      | ● CI Cuero Inglés    | ● LM Latón Mate     | ● NM Níquel Mate | ● NS Níquel Satinado    | ● PL Plata         |                       |



**Uovo** LAT

Opciones	Ref.	CB	CI	CS	CU	LM	NM	PB		
Ø50  10	<b>UOVO ROSETA</b>	92.34	82.16	92.34	82.16	82.16	94.79	82.16	1	20
241  42	<b>UOVO PLACA</b>	92.34	82.16	92.34	82.16	82.16	94.79	82.16	1	20



**Polo** PORCELANA (sin muelle) LAT

Opciones	Ref.	CI	NM	PB		
Ø50  10	<b>POLO PORC. ROSETA</b>	94.79	104.87	94.79	1	20
241  42	<b>POLO PORC. PLACA</b>	94.79	10.487	94.79	1	20

**Polo** LAT

Opciones	Ref.	CB	CI	CS	CU	LM	NM	PB		
Ø50  10	<b>POLO ROSETA</b>	92.34	82.16	92.34	82.16	82.16	94.79	82.16	1	20
241  42	<b>POLO PLACA</b>	92.34	82.16	92.34	82.16	82.16	94.79	82.16	1	20





**SV-R650** ZK

Opciones	CB	CS	NM		
Ø50	24.85	24.85	24.85	1	20



**SV-C650** ZK

Opciones	CB	CS	NM		
50x50	25.72	25.72	25.72	1	20



**SV-R950** ZK

Opciones	NM		
Ø50	29.61	1	20



**SV-C950** ZK

Opciones	NM		
50x50	32.19	1	20

JANDEL ORIGINAL



- AN Anticato
- CB Cromo Brillo
- CS Cromo Satinado
- MR Marrón
- NMM Níquel Mate Mate
- PB Pulido Brillo
- PVL M PVD Lat. Mate
- ANTR Antracita
- CC Cromo Combinado
- CU Cuero
- NE Negro
- NM.OP Níq. Mat. Opaco
- PS Pulido Satin.
- BL Blanco
- CI Cuero Inglés
- LM Latón Mate
- NM Níquel Mate
- NS Níquel Satinado
- PL Plata

## Manivelas

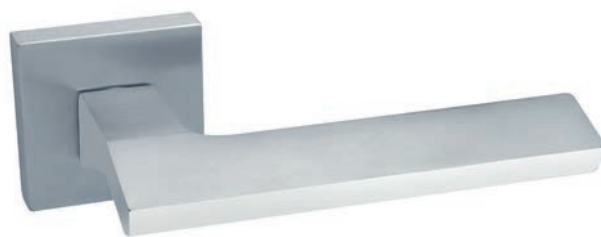

### 3012 Laura LAT

Opciones	Ref.	CB	CC	CS	NM		
50x50 10"	<b>3012</b>	91.88	91.88	91.88	95.08	1	20
269	<b>3512</b>	127.08	127.08	127.08	130.22	1	20
241	<b>4512</b>	96.59	96.59	96.59	100.84	1	20

### 3022 Natalia LAT

Opciones	Ref.	CB	CC	CS	NM		
50x50 10"	<b>3022</b>	91.88	91.88	91.88	95.08	1	20
269	<b>3522</b>	127.08	127.08	127.08	130.22	1	20
241	<b>4522</b>	96.59	96.59	96.59	100.84	1	20

JANDEL ORIGINAL



### 3070 Iber LAT

Opciones	Ref.	CC	CI	CS	NM		
50x50 10"	<b>3070</b>	95.98	83.02	95.98	99.54	1	20
269	<b>3570</b>	126.47	117.65	126.47	136.16	1	20
241	<b>4570</b>	101.02	88.10	101.02	104.58	1	20

### 3080 Pilar LAT

Opciones	Ref.	CC	CI	CS	LM	NM	PB		
50x50 10"	<b>3080</b>	95.98	81.11	95.98	81.11	99.54	79.85	1	20
269	<b>3580</b>	131.15	111.50	131.15	111.50	134.82	110.24	1	20
241	<b>4580</b>	101.02	86.19	101.02	86.19	104.58	84.89	1	20



### 3082 Kubic LAT

Opc.	Ref.	CB	CC	CS	LM	NM	PB		
50x50 10"	<b>3082</b>	93.46	93.46	93.46	83.63	93.46	83.63	1	20
269	<b>3582</b>	126.90	126.90	126.90	117.08	126.90	117.08	1	20
241	<b>4582</b>	98.39	98.39	98.39	96.45	98.39	96.45	1	20

### 3413 Elle ZK

Opc.	Ref.	ANTR	BL	CB	CI	CS	LM	NE	NM	PVLM		
50x50 10"	<b>3413</b>	27.78	27.78	27.78	27.78	27.78	27.78	27.78	27.78	81.78	1	20
269	<b>3513</b>	-	-	67.93	67.93	67.93	67.93	67.93	67.93	-	1	20
241	<b>4513</b>	54.37	53.31	58.81	54.37	58.81	54.37	61.27	61.27	114.14	1	20





## 3424 u an ZK

Opciones	Ref.	CB	CS	NM		
50X50	<b>3424</b>	27.78	27.78	27.78	1	20
269	<b>3524</b>	67.93	67.93	67.93	1	20
241	<b>4524</b>	50.18	50.18	50.18	1	20



## 3429 Dolce ZK

Opciones	Ref.	CB	CS	NE	NMM		
50X50	<b>3429</b>	30.02	30.02	30.02	30.02	1	20
269	<b>3529</b>	70.17	70.17	70.17	-	1	20
241	<b>4529</b>	52.42	52.42	52.42	52.42	1	20



## 3434 Virgo ZK

Opciones	Ref.	CB	CS	NE	NM		
50X50	<b>3434</b>	27.78	27.78	27.78	27.78	1	20
269	<b>3534</b>	67.93	67.93	67.93	67.93	1	20
241	<b>4534</b>	50.18	50.18	50.18	50.18	1	20

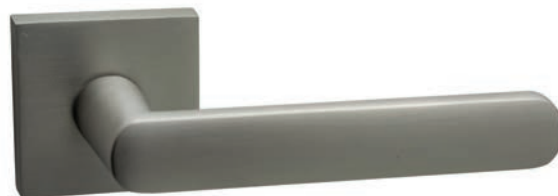

## 3449 Clubb ZK

Opciones	Ref.	BL	CB	CS	NE	NMM		
50X50	<b>3449</b>	30.02	30.02	30.02	30.02	30.02	1	20
269	<b>3549</b>	-	70.17	70.17	70.17	-	1	20
241	<b>4549</b>	52.42	52.42	52.42	52.42	52.42	1	20





- AN Anticato
- CB Cromo Brillo
- CS Cromo Satinado
- MR Marrón
- NMM Níquel Mate Mate
- PB Pulido Brillo
- PVLML PVD Lat. Mate
- ANTR Antracita
- CC Cromo Combinado
- CU Cuero
- NE Negro
- NM.OP Niq. Mat. Opaco
- PS Pulido Satin.
- BL Blanco
- CI Cuero Inglés
- LM Latón Mate
- NM Níquel Mate
- NS Níquel Satinado
- PL Plata

JANDEL ORIGINAL

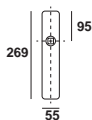



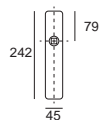

**3570** LAT

CC	CI	CS	NM		
126.47	117.65	126.47	136.16	1	20



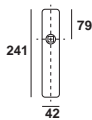

**SV-PC65** ZK

CB	CS	NM		
29.45	27.40	30.85	1	20







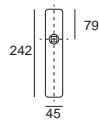















**4513** LAT-ZK

ANTR	BL	CB	CC	CI	CS	LM	NE	NM	PVLM		
54.37	53.41	58.81	65.38	54.37	58.81	54.37	61.27	61.27	114.14	1	20



**SV-P650** ZK

CB	CS	NM		
29.80	28.38	29.80	1	20

-  AN Anticato
-  CB Cromo Brillo
-  CS Cromo Satinado
-  MR Marrón
-  NMM Níquel Mate Mate
-  PB Pulido Brillo
-  PVLM PVD Lat. Mate
-  ANTR Antracita
-  CC Cromo Combinado
-  CU Cuero
-  NE Negro
-  NM.OP Niq. Mat. Opaco
-  PS Pulido Satin.
-  BL Blanco
-  CI Cuero Inglés
-  LM Latón Mate
-  NM Níquel Mate
-  NS Níquel Satinado
-  PL Plata

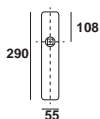

**3223** LAT

CI	PB		
124.67	124.67	1	20

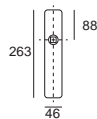

NEW

**EQ-9690** LAT

CI		
55.98	1	20

\*Porcelana craquelé

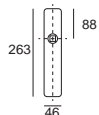

NEW

**EQ-9691** LAT

CI		
55.98	1	20

\*Porcelana beige

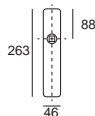

NEW

**EQ-9692** LAT

CI		
55.98	1	20

\*Porcelana blanca



**8045** LAT

CI	NM	PS		
67.02	77.76	67.02	1	20



**1605** LAT

CI	CS	LM	NM	PB		
48.24	55.48	48.24	58.11	46.77	1	20



**NEW**

**4459** LAT-ZK

AN	CI	NE	PL		
35.45	34.05	34.54	35.45	1	20



JANDEL ORIGINAL

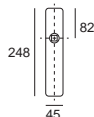

- AN Anticato
- ANTR Antracita
- BL Blanco
- CB Cromo Brillo
- CC Cromo Combinado
- CI Cuero Inglés
- CS Cromo Satinado
- CU Cuero
- LM Latón Mate
- MR Marrón
- NE Negro
- NM Níquel Mate
- NMM Níquel Mate Mate
- NM.OP Níq. Mat. Opaco
- NS Níquel Satinado
- PB Pulido Brillo
- PS Pulido Satin.
- PL Plata
- PVLM PVD Lat. Mate

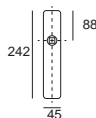

Ref.	Opciones	mm	PB		
<b>EQ-100B</b>	g o. Manie la	248x45	22.29	1	20
<b>EQ-M100</b>	Manillón	248x45	15.60	2	40
<b>EQ-L100</b>	Placa limpieza	248x45	6.83	10	100
<b>EQ-C100</b>	Asa corta c/placa	248x45	15.60	2	40
<b>EQ-T203</b>	Tirador armario	123x35	3.83	20	200
<b>EQ-A203</b>	Tirador maletero	83x35	2.78	20	200
<b>EQ-P100</b>	Placa pomo fijo	248x45	17.56	2	40
<b>EQ-P100MV</b>	Placa pomo móv l	248x45	18.48	2	40

LAT



Ref.	Opciones	mm	CU	PS		
<b>EQ-297</b>	g o. Manie la	242x45	22.60	22.60	1	20
<b>EQ-M297</b>	Manillón	242x45	15.60	15.60	2	40
<b>EQ-L297</b>	Placa limpieza	242x45	7.54	7.54	10	100
<b>EQ-C297</b>	Asa corta c/placa	242x45	15.60	15.60	2	40
<b>EQ-T400</b>	Tirador armario	123x35	4.87	4.87	20	200
<b>EQ-A400</b>	Tirador maletero	83x35	3.25	3.25	20	200
<b>EQ-P297</b>	Placa pomo fijo	242x45	17.56	17.56	2	40
<b>EQ-P297MV</b>	Placa pomo móv l	242x45	18.27	18.27	2	40

LAT

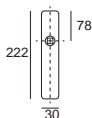

Ref.	Opciones	mm	CU	NM	PB		
<b>EQ-330</b>	g o. Maniñe la	222x30	24.72	24.72	24.72	1	20

LAT

JANDEL ORIGINAL

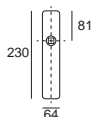

Ref.	Opciones	mm	CU	PS		
<b>EQ-525</b>	g o. Maniñe la	230x64	37.60	37.60	1	20
<b>EQ-M525</b>	Manillón	230x64	16.47	16.47	2	40
<b>EQ-L525</b>	Placa limpieza	230x64	9.49	9.49	10	100
<b>EQ-C525</b>	Asa corta c/placa	230x64	16.47	16.47	2	40
<b>EQ-P525</b>	Placa pomo fijo	230x64	21.85	21.85	2	40
<b>EQ-P525MV</b>	Placa pomo móv l	230x60	22.56	22.56	2	40

LAT

- AN Anticato
- CB Cromo Brillo
- CS Cromo Satinado
- MR Marrón
- NMM Níquel Mate Mate
- PB Pulido Brillo
- PVLML PVD Lat. Mate
- ANTR Antracita
- CC Cromo Combinado
- CU Cuero
- NE Negro
- NM.OP Níq. Mat. Opaco
- PS Pulido Satin.
- BL Blanco
- CI Cuero Inglés
- LM Latón Mate
- NM Níquel Mate
- NS Níquel Satinado
- PL Plata

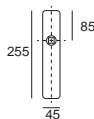

Ref.	Opciones	mm	CU	PS		
<b>EQ-796</b>	g o. Manie la	255x45	22.29	22.29	1	20
<b>EQ-M796</b>	Manillón	255x45	15.60	15.60	2	40
<b>EQ-L796</b>	Placa limpieza	255x45	6.83	6.83	10	100
<b>EQ-C796</b>	Asa corta c/placa	255x45	15.60	15.60	2	40
<b>EQ-T599</b>	Tirador armario	129x33	4.87	4.87	20	200
<b>EQ-A599</b>	Tirador maletero	89x33	3.58	3.58	20	200
<b>EQ-P796</b>	Placa pomo fijo	255x45	16.85	16.85	2	40
<b>EQ-P796MV</b>	Placa pomo móv	255x45	17.56	17.56	2	40

LAT

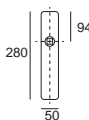

Ref.	Opciones	mm	CU	PS		
<b>EQ-1599</b>	g o. Manie la	280x50	27.25	27.25	1	20
<b>EQ-M599</b>	Manillón	280x50	15.60	15.60	2	40
<b>EQ-L599</b>	Placa limpieza	280x50	8.60	8.60	10	100
<b>EQ-C599</b>	Asa corta c/placa	280x50	15.60	15.60	2	40
<b>EQ-T599</b>	Tirador armario	128x33	3.58	4.87	20	200
<b>EQ-A599</b>	Tirador maletero	88x33	3.58	3.58	20	200
<b>EQ-P599</b>	Placa pomo fijo	280x50	21.85	21.85	2	40
<b>EQ-P599MV</b>	Placa pomo móv	280x50	22.56	22.56	2	40

LAT



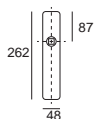

Ref.	Opciones	mm	CU	PS		
<b>EQ-2733</b>	g o. Maniñe la	262x48	31.76	31.76	1	20
<b>EQ-M733</b>	Manillón	262x48	15.05	15.05	2	40
<b>EQ-L733</b>	Placa limpieza	262x48	7.83	7.83	10	100
<b>EQ-C733</b>	Asa corta c/placa	262x48	15.05	15.05	2	40
<b>EQ-T400</b>	Tirador armario	128x33	4.87	4.87	20	200
<b>EQ-A400</b>	Tirador maletero	88x33	3.25	3.25	20	200
<b>EQ-P733</b>	Placa pomo fijo	262x48	20.43	20.43	2	40
<b>EQ-P733MV</b>	Placa pomo móv l	262x48	21.14	21.14	2	40

LAT

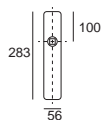



Ref.	Opciones	mm	NM	PS		
<b>EQ-3800</b>	g o. Maniñe la	283X56	43.05	43.05	1	20
<b>EQ-M380</b>	Manillón	283X56	15.85	16.85	2	40
<b>EQ-L800</b>	Placa limpieza	283X56	10.23	10.23	10	100
<b>EQ-C800</b>	Asa corta c/placa	283X56	16.85	16.85	2	40
<b>EQ-T400</b>	Tirador armario	128x33	4.87	4.87	20	200
<b>EQ-A400</b>	Tirador maletero	88x33	3.58	3.25	20	200
<b>EQ-P800</b>	Placa pomo fijo	283X56	22.56	22.56	2	40
<b>EQ-P800MV</b>	Placa pomo móv l	283x56	23.29	23.29	2	40

LAT

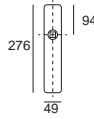

- AN Anticato
- ANTR Antracita
- BL Blanco
- CB Cromo Brillo
- CC Cromo Combinado
- CI Cuero Inglés
- CS Cromo Satinado
- CU Cuero
- LM Latón Mate
- MR Marrón
- NE Negro
- NM Níquel Mate
- NMM Níquel Mate Mate
- NM.OP Níq. Mat. Opaco
- NS Níquel Satinado
- PB Pulido Brillo
- PS Pulido Satin.
- PL Plata
- PVLML PVD Lat. Mate



Ref.	Opciones	mm	CU	PS		
<b>EQ-4402</b>	g o. Maniñe la	276x49	40.78	40.78	1	20
<b>EQ-M402</b>	Manillón	276x49	16.47	16.47	2	40
<b>EQ-L402</b>	Placa limpieza	276x49	9.87	9.87	10	100
<b>EQ-C402</b>	Asa corta c/placa	276x49	16.47	16.47	2	40
<b>EQ-T599</b>	Tirador armario	128x33	4.87	4.87	20	200
<b>EQ-A599</b>	Tirador maletero	88x33	3.58	3.58	20	200
<b>EQ-P402</b>	Placa pomo fijo	276x49	22.56	22.56	2	40
<b>EQ-P402MV</b>	Placa pomo móv	276x49	23.29	23.29	2	40

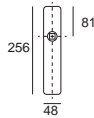

LAT

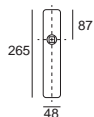

Ref.	Opciones	mm	CU	PS		
<b>EQ-4406</b>	g o. Maniñe la	256x48	30.74	30.74	1	20
<b>EQ-M406</b>	Manillón	256x48	16.14	16.14	2	40
<b>EQ-L406</b>	Placa limpieza	256x48	7.74	7.74	10	100
<b>EQ-C406</b>	Asa corta c/placa	256x48	16.14	16.14	2	40
<b>EQ-T400</b>	Tirador armario	128x33	4.87	4.87	20	200
<b>EQ-A400</b>	Tirador maletero	88x33	3.25	3.25	20	200
<b>EQ-P406</b>	Placa pomo fijo	256x48	20.76	20.76	2	40
<b>EQ-P406MV</b>	Placa pomo móv	256x48	21.47	21.47	2	40

LAT



Ref.	Opciones	mm	CU	NM	PS		
<b>EQ-4419</b>	g o. Manie la	265x48	30.67	30.67	30.67	1	20
<b>EQ-M419</b>	Manillón	265x48	14.32	14.32	14.32	2	40
<b>EQ-L419</b>	Placa limpieza	265x48	7.74	7.74	7.74	10	100
<b>EQ-C419</b>	Asa corta c/placa	265x48	14.32	14.32	14.32	2	40
<b>EQ-T400</b>	Tirador armario	128x33	4.87	4.87	4.87	20	200
<b>EQ-A400</b>	Tirador maletero	88x33	3.25	3.58	3.25	20	200
<b>EQ-P419</b>	Placa pomo fijo	265x48	19.72	19.72	19.72	2	40
<b>EQ-P419MV</b>	Placa pomo móv l	265x48	20.43	20.43	20.43	2	40



LAT

JANDEL ORIGINAL



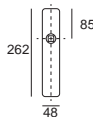

- AN Anticato
- CB Cromo Brillo
- CS Cromo Satinado
- MR Marrón
- NMM Níquel Mate Mate
- PB Pulido Brillo
- PVLML PVD Lat. Mate
- ANTR Antracita
- CC Cromo Combinado
- CU Cuero
- NE Negro
- NM.OP Níq. Mat. Opaco
- PS Pulido Satin.
- BL Blanco
- CI Cuero Inglés
- LM Latón Mate
- NM Níquel Mate
- NS Níquel Satinado
- PL Plata



Ref.	Opciones	mm	CU	PS		
<b>EQ-4423</b>	g o. Manillero la	262x48	36.96	36.96	1	20
<b>EQ-M423</b>	Manillón	262x48	15.40	15.40	2	40
<b>EQ-L423</b>	Placa limpieza	262x48	7.74	7.74	10	100
<b>EQ-C423</b>	Asa corta c/placa	262x48	15.40	15.40	2	40
<b>EQ-T424</b>	Tirador armario	131x35	3.58	3.58	20	200
<b>EQ-A424</b>	Tirador maletero	85x35	3.25	3.25	20	200
<b>EQ-P423</b>	Placa pomo fijo	262x48	20.43	20.43	2	40
<b>EQ-P423MV</b>	Placa pomo móv l	262x48	21.14	21.14	2	40

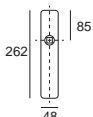

LAT



Ref.	Opciones	mm	CU	PS		
<b>EQ-4424</b>	g o. Manillero la	262x48	32.20	32.20	1	20
<b>EQ-M424</b>	Manillón	262x48	15.40	15.40	2	40
<b>EQ-L424</b>	Placa limpieza	262x48	8.07	8.07	10	100
<b>EQ-C424</b>	Asa corta c/placa	262x48	15.40	15.40	2	40
<b>EQ-T424</b>	Tirador armario	131x35	3.58	3.58	20	200
<b>EQ-A424</b>	Tirador maletero	85x35	3.25	3.25	20	200
<b>EQ-P424</b>	Placa pomo fijo	262x48	20.43	20.43	2	40
<b>EQ-P424MV</b>	Placa pomo móv l	262x48	21.14	21.14	2	40

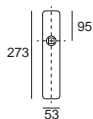

LAT

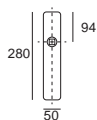

Ref.	Opciones	mm	CU	PS		
<b>EQ-4450</b>	g o. Manie la	273X53	35.12	35.12	1	20
<b>EQ-M450</b>	Manillón	273X53	15.40	15.40	2	40
<b>EQ-L450</b>	Placa limpieza	273X53	8.07	8.07	10	100
<b>EQ-C450</b>	Asa corta c/placa	273X53	15.40	15.40	2	40
<b>EQ-T400</b>	Tirador armario	128x33	4.87	4.87	20	200
<b>EQ-A400</b>	Tirador maletero	88x33	3.25	3.25	20	200
<b>EQ-P450</b>	Placa pomo fijo	273X53	18.98	18.98	2	40
<b>EQ-P450MV</b>	Placa pomo móv l	273x53	19.72	19.72	2	40

LAT





Ref.	Opciones	mm	CU	PS		
<b>EQ-8300</b>	g o. Manie la	280x50	34.29	34.29	1	20
<b>EQ-M300</b>	Manillón	280x50	15.94	15.94	2	40
<b>EQ-L300</b>	Placa limpieza	280x50	8.60	8.60	10	100
<b>EQ-C300</b>	Asa corta c/placa	280x50	15.94	15.94	2	40
<b>EQ-T400</b>	Tirador armario	128x33	4.87	4.87	20	200
<b>EQ-A400</b>	Tirador maletero	88x33	3.25	3.25	20	200
<b>EQ-P300</b>	Placa pomo fijo	280x50	20.76	20.76	2	40
<b>EQ-P300MV</b>	Placa pomo móv l	280x50	21.47	21.47	2	40

LAT

- AN Anticato
- ANTR Antracita
- BL Blanco
- CB Cromo Brillo
- CC Cromo Combinado
- CI Cuero Inglés
- CS Cromo Satinado
- CU Cuero
- LM Latón Mate
- MR Marrón
- NE Negro
- NM Níquel Mate
- NMM Níquel Mate Mate
- NM.OP Níq. Mat. Opaco
- NS Níquel Satinado
- PB Pulido Brillo
- PS Pulido Satin.
- PL Plata
- PVLML PVD Lat. Mate

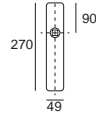
JANDEL ORIGINAL



Ref.	Opciones	mm	CU	PS		
<b>EQ-9500</b>	g o. Manillero la	270x49	31.45	31.45	1	20
<b>EQ-M500</b>	Manillón	270x49	16.14	16.14	2	40
<b>EQ-L500</b>	Placa limpieza	270x49	8.07	8.07	10	100
<b>EQ-C500</b>	Asa corta c/placa	270x49	16.14	16.14	2	40
<b>EQ-T400</b>	Tirador armario	128x33	4.87	4.87	20	200
<b>EQ-A400</b>	Tirador maletero	88x33	3.25	3.25	20	200
<b>EQ-P500</b>	Placa pomo fijo	270x49	20.43	20.43	2	40
<b>EQ-P500MV</b>	Placa pomo móvil	270x49	21.14	21.14	2	40

LAT

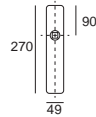

Ref.	Opciones	mm	CU	PS		
<b>EQ-9501</b>	g o. Manillero la	270x49	25.27	24.29	1	20
<b>EQ-M500</b>	Manillón	270x49	16.14	16.14	2	40
<b>EQ-L500</b>	Placa limpieza	270x49	8.07	8.07	10	100
<b>EQ-C500</b>	Asa corta c/placa	270x49	16.14	16.14	2	40
<b>EQ-T400</b>	Tirador armario	128x33	4.87	4.87	20	200
<b>EQ-A400</b>	Tirador maletero	88x33	3.25	3.25	20	200
<b>EQ-P500</b>	Placa pomo fijo	270x49	20.43	20.43	2	40
<b>EQ-P500MV</b>	Placa pomo móvil	270x49	21.14	21.14	2	40

LAT



Ref.	Opciones	mm	CI	CU	PS		
<b>EQ-9600</b>	g o. Manie la	263x46	30.27	30.27	30.27	1	20
<b>EQ-M600</b>	Manillón	263x46	16.14	16.14	16.14	2	40
<b>EQ-L600</b>	Placa limpieza	263x46	8.25	8.25	8.25	10	100
<b>EQ-C600</b>	Asa corta c/placa	263x46	16.14	16.14	16.14	2	40
<b>EQ-T400</b>	Tirador armario	128x33	4.67	4.87	4.87	20	200
<b>EQ-A400</b>	Tirador maletero	88x33	3.58	3.25	3.25	20	200
<b>EQ-P600</b>	Placa pomo fijo	263x46	21.85	21.85	21.85	2	40
<b>EQ-P600MV</b>	Placa pomo móv	263x46	22.56	22.56	22.56	2	40

LAT

JANDEL ORIGINAL

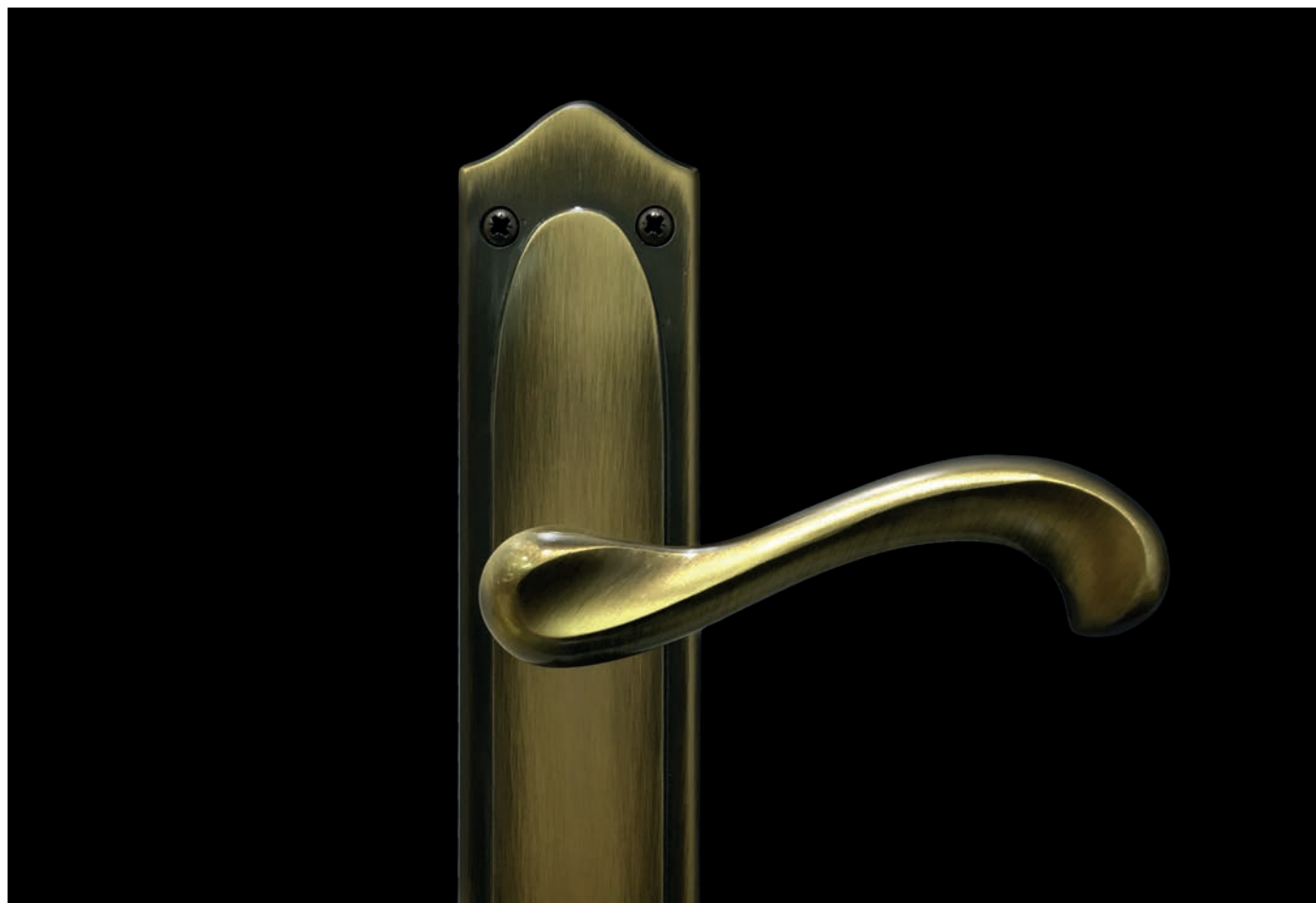

- AN Anticato
- CB Cromo Brillo
- CS Cromo Satinado
- MR Marrón
- NMM Níquel Mate Mate
- PB Pulido Brillo
- PVLM PVD Lat. Mate
- ANTR Antracita
- CC Cromo Combinado
- CU Cuero
- NE Negro
- NM.OP Níq. Mat. Opaco
- PS Pulido Satin.
- BL Blanco
- CI Cuero Inglés
- LM Latón Mate
- NM Níquel Mate
- NS Níquel Satinado
- PL Plata

JANDEL ORIGINAL





Estas referencias se pueden montar con todas las manivelas y en todos los acabados de nuestra serie **Jandel Original**

## PLACAS LAT

**35** Placa manivela



**45** Placa manivela



**15** Placa manivela



**00** Placa manivela Sin muelle



## ROSETAS ZK

**CXC** 64 x 30 mm  
Roseta rect.  
Con muelle



**CX** 64 x 30 mm  
Roseta oval  
Con muelle



## GRISÁN ZK

**GC** 64 x 30 mm  
Placa grisán  
DK rectangular



**G** 64 x 30 mm  
Placa grisán  
DK oval



Ref.	AN	ANTR	BL	CB	CI	CS	CU	LM	MR	NE	NM	NMM	PB	PL	PVLM
<b>35</b>	21.89	-	-	22.76	21.89	22.76	21.89	21.89	21.89	24.52	25.38	-	21.02	-	-
<b>45</b>	12.23	12.23	12.23	12.68	12.23	12.68	12.23	12.23	12.23	13.12	13.12	12.23	12.23	-	32.20
<b>15</b>	9.67	9.67	9.67	10.50	9.67	10.50	9.67	9.67	9.67	11.40	11.40	9.67	8.77	14.36	32.20
<b>00</b>	12.68	-	13.44	13.60	13.12	13.60	12.68	12.68	12.68	14.44	14.44	-	12.48	18.56	-
<b>GC</b>	-	-	11.52	12.32	12.48	12.32	-	10.76	-	11.52	12.80	-	10.31	-	-
<b>G</b>	10.76	-	9.28	10.40	10.56	10.40	10.76	9.92	10.76	12.39	10.88	-	9.92	15.33	-
<b>CXC</b>	-	-	15.68	16.48	16.64	16.48	-	10.40	-	15.68	17.12	-	9.89	-	-
<b>CX</b>	10.40	-	10.24	11.04	11.20	11.04	10.40	10.56	10.40	12.02	11.68	-	10.56	16.32	-

- AN Anticato
- ANTR Antracita
- BL Blanco
- CB Cromo Brillo
- CC Cromo Combinado
- CI Cuero Inglés
- CS Cromo Satinado
- CU Cuero
- LM Latón Mate
- MR Marrón
- NE Negro
- NM Níquel Mate
- NMM Níquel Mate Mate
- NM.OP Níq. Mat. Opaco
- NS Níquel Satinado
- PB Pulido Brillo
- PS Pulido Satin.
- PL Plata
- PVLM PVD Lat. Mate

JANDEL ORIGINAL

Ref.	mm (centr.)	CB	CI	CS	CU	LM	NM	PB	
<b>C302</b>	150 (ROSETA)	50.28	38.92	50.28	38.92	38.92	50.28	37.19	5
<b>C302</b>	150 (PLACA)	52.48	41.57	52.48	41.57	41.57	52.48	39.36	2

Ref.	mm (centr.)	AN	CI	CU	NM	PB	PL	
<b>EQ-M890</b>	220	35.27	35.27	35.27	35.27	35.27	35.27	2

Porcelana craquelé

Ref.	mm (centr.)	AN	CI	CU	NM	PB	PL	
<b>EQ-M891</b>	220	35.27	35.27	35.27	35.27	35.27	35.27	2

Porcelana beige

Ref.	mm (centr.)	AN	CI	CU	NM	PB	PL	
<b>EQ-M892</b>	220	35.27	35.27	35.27	35.27	35.27	35.27	2

Porcelana blanca

JANDEL ORIGINAL



**C302** LAT

**EQ-M890** LAT



**EQ-M891** LAT



**EQ-M892** LAT





Ref.	mm (entre cent.)	CB	CC	CI	CS	LM	NM	PB	
<b>C307</b>	200	101.12	101.12	89.86	101.12	89.86	106.79	89.86	2

Ref.	mm (entre cent.)	CB	CC	CI	CS	LM	NM	PB	
<b>C308</b>	200	114.56	114.56	103.40	114.56	103.40	120.26	103.40	2

Ref.	mm (entre cent.)	CB	CC	CI	CU	CS	LM	NM	PB	
<b>C309</b>	200	95.56	95.56	84.26	84.26	95.56	84.26	101.12	84.26	2

Ref.	mm (entre cent.)	AN	CB	CI	CS	CU	LM	MR	NE	NM	PB	PL	
<b>C310</b>	200	17.18	16.18	16.80	16.18	16.18	16.58	17.18	16.80	16.18	16.58	17.18	5
<b>C312</b>	160	23.17	25.83	23.17	25.83	23.17	23.17	23.17	27.56	27.56	22.31	33.22	10

**C310 LAT**  
**C312 LAT**

JANDEL ORIGINAL

- AN Anticato
- ANTR Antracita
- BL Blanco
- CB Cromo Brillo
- CC Cromo Combinado
- CI Cuero Inglés
- CS Cromo Satinado
- CU Cuero
- LM Latón Mate
- MR Marrón
- NE Negro
- NM Níquel Mate
- NMM Níquel Mate Mate
- NM.OP Níq. Mat. Opaco
- NS Níquel Satinado
- PB Pulido Brillo
- PS Pulido Satin.
- PL Plata
- PVL M PVD Lat. Mate



**C311** LAT





**C313** LAT



**C316** LAT

Ref.	mm (entre cent.)	AN	CB	CI	CS	CU	LM	MR	NM	PB	
<b>C311</b>	200	26.24	34.53	26.24	34.53	26.24	26.24	26.24	36.16	25.73	10

Ref.	mm (entre cent.)	CB	CI	CS	CU	LM	NM	PB	
<b>C313</b>	200	49.54	49.54	49.54	49.54	49.54	49.54	42.82	5

Ref.	mm (entre cent.)	CB	CC	CS	NM	
<b>C316</b>	200	96.23	96.23	96.23	103.65	2



**C349** ZK



**C320** LAT

Ref.	mm (entre cent.)	CB	CC	CS	NM	
<b>C320</b>	200	92.84	92.84	92.84	92.84	1
	250	109.28	109.28	109.28	109.28	1
	300	125.67	125.67	125.67	131.11	1
	400	158.40	158.40	158.40	163.88	1
	500	191.17	191.17	191.17	196.64	1

Ref.	mm (entre cent.)	ANTR	BL	CB	CS	NE	NMM	
<b>C349</b>	200	20.16	20.16	20.16	19.56	20.16	19.56	1

- AN Anticato
- ANTR Antracita
- BL Blanco
- CB Cromo Brillo
- CC Cromo Combinado
- CI Cuero Inglés
- CS Cromo Satinado
- CU Cuero
- LM Latón Mate
- MR Marrón
- NE Negro
- NM Níquel Mate
- NMM Níquel Mate Mate
- NM.OP Níq. Mat. Opaco
- NS Níquel Satinado
- PB Pulido Brillo
- PS Pulido Satin.
- PVL M PVD Lat. Mate
- PL Plata

JANDEL ORIGINAL



**C327** ZK

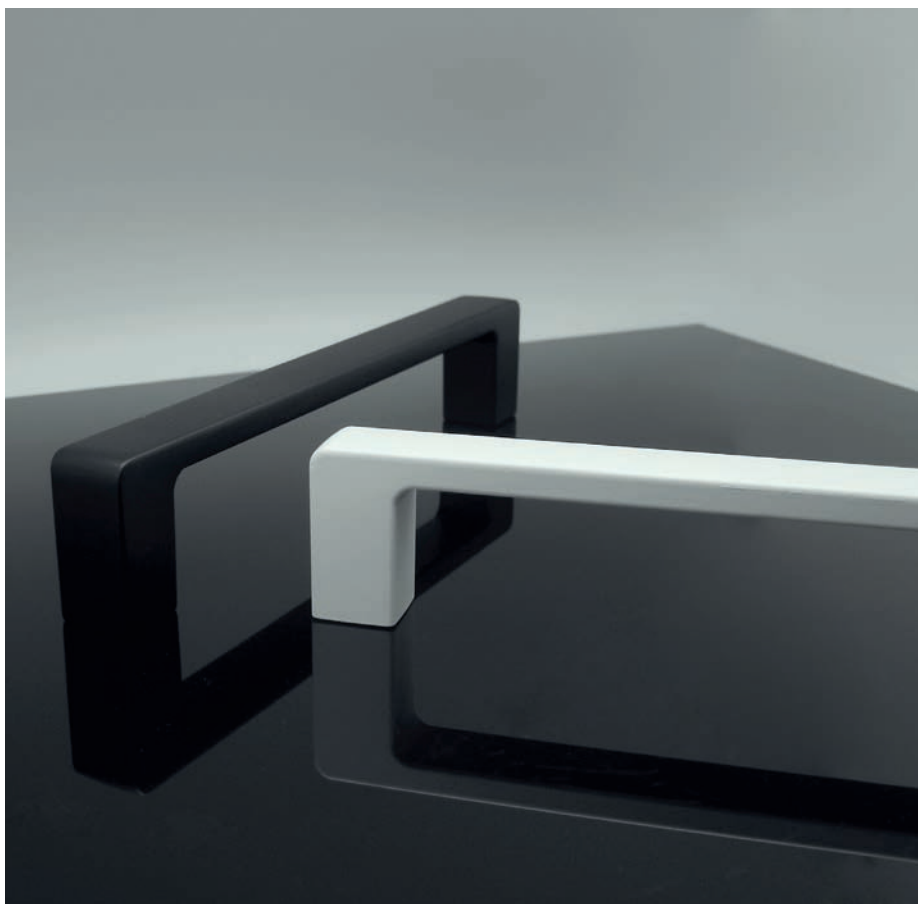

Ref.	mm (entre cent.)	ANTR	BL	CB	CI	CS	LM	NE	NMM	NS	PB	PVLM	
<b>C327</b>	210	21.75	21.75	20.68	20.68	20.68	20.68	22.03	21.24	20.68	20.68	65.58	2

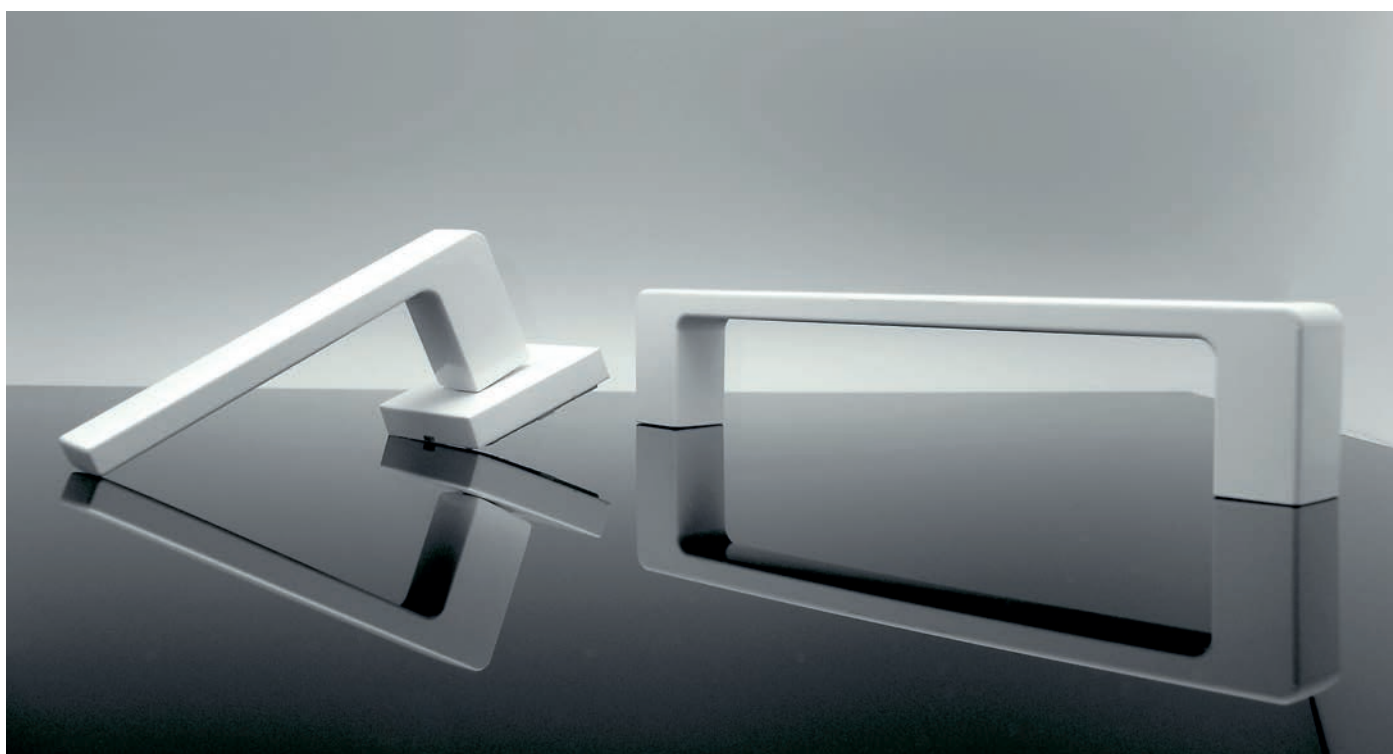



C322 LAT



C326 LAT

JANDEL ORIGINAL

Ref.	mm (entre cent.)	CI	CS	CU	LM	NM	PB	
C322	210	91.17	96.10	91.17	91.17	96.61	86.21	2

Ref.	mm (entre cent.)	CI	CU	LM	MR	NM	PB	PL	
C326	225	87.59	87.59	87.59	87.59	107.52	87.59	112.45	2

- AN Anticato
- ANTR Antracita
- BL Blanco
- CB Cromo Brillo
- CC Cromo Combinado
- CI Cuero Inglés
- CS Cromo Satinado
- CU Cuero
- LM Latón Mate
- MR Marrón
- NE Negro
- NM Níquel Mate
- NMM Níquel Mate Mate
- NM.OP Níq. Mat. Opaco
- NS Níquel Satinado
- PB Pulido Brillo
- PS Pulido Satin.
- PL Plata
- PVLM PVD Lat. Mate

JANDEL ORIGINAL







**C359** ZK

Ref.	mm (entre cent.)	AN	CI	NE	PL	
<b>C359</b>	220	20.40	19.23	19.69	20.40	2



**C800** LAT

Ref.	mm (entre cent.)	CI	NM	PS	
<b>C800</b>	280x50	48.13	56.84	48.13	2

JANDEL ORIGINAL

- AN Anticato
- ANTR Antracita
- BL Blanco
- CB Cromo Brillo
- CC Cromo Combinado
- CI Cuero Inglés
- CS Cromo Satinado
- CU Cuero
- LM Latón Mate
- MR Marrón
- NE Negro
- NM Níquel Mate
- NMM Níquel Mate Mate
- NM.OP Níq. Mat. Opaco
- NS Níquel Satinado
- PB Pulido Brillo
- PS Pulido Satin.
- PL Plata
- PVL M PVD Lat. Mate



Ref.	CI	CU	LM	MR	NM	PB	PL	
<b>CG75</b> LAT	33.22	33.22	33.22	33.22	36.68	33.22	46.08	2



Ref.	CI	LM	NM	PB	
<b>CGKA</b> ZK	19.81	19.81	21.64	18.98	2

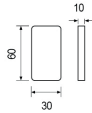

JANDEL ORIGINAL

Ref.	CB	CS	NE	NM	
<b>G13C</b> ZK	34.47	31.04	30.63	31.04	2



- AN Anticato
- ANTR Antracita
- BL Blanco
- CB Cromo Brillo
- CC Cromo Combinado
- CI Cuero Inglés
- CS Cromo Satinado
- CU Cuero
- LM Latón Mate
- MR Marrón
- NE Negro
- NM Níquel Mate
- NMM Níquel Mate Mate
- NM.OP Níq. Mat. Opaco
- NS Níquel Satinado
- PB Pulido Brillo
- PS Pulido Satin.
- PL Plata
- PVL M PVD Lat. Mate



Ref.	mm	PVD	
<b>SV-105P</b>	Ø85 (base)	15.93	1

ZK



Ref.	mm	CI	CU	LM	NM	PS	
<b>C207</b>	Ø90 (base)	21.27	21.27	21.27	21.27	21.27	1

LAT



Ref.	mm	CI	CU	PS	
<b>C208</b>	Ø85 (base)	16.12	16.12	16.12	1

LAT



Ref.	mm	BL	LM	NE	NM	PB	
<b>EQ-1085</b>	Ø85 (base)	11.65	11.65	11.65	11.65	11.65	1

LAT



Ref.	mm	CS	CU	NM	PB	
<b>EQ-1095</b>	Ø85 (base)	11.65	11.65	11.65	11.65	1

LAT



- AN Anticato
- CB Cromo Brillo
- CS Cromo Satinado
- MR Marrón
- NMM Níquel Mate Mate
- PB Pulido Brillo
- PVL M PVD Lat. Mate
- ANTR Antracita
- CC Cromo Combinado
- CU Cuero
- NE Negro
- NM.OP Níq. Mat. Opaco
- PS Pulido Satin.
- BL Blanco
- CI Cuero Inglés
- LM Latón Mate
- NM Níquel Mate
- NS Níquel Satinado
- PL Plata

JANDEL ORIGINAL



Ref.	mm	CB	CS	LM	NE	NM	PB	
<b>C210</b>	Ø67 (Ø38 base)	70.40	70.40	70.40	70.40	70.40	70.40	1

LAT





JANDEL ORIGINAL

Ref.	mm	CB	CI	CS	LM	NE	NM	PB	
<b>C209</b>	67x67 50x50 (base)	50.28	49.41	50.28	47.59	52.55	52.55	47.59	1

LAT



- AN Anticato
- CB Cromo Brillo
- CS Cromo Satinado
- MR Marrón
- NMM Níquel Mate Mate
- PB Pulido Brillo
- PVL M PVD Lat. Mate
- ANTR Antracita
- CC Cromo Combinado
- CU Cuero
- NE Negro
- NM.OP Níq. Mat. Opaco
- PS Pulido Satin.
- BL Blanco
- CI Cuero Inglés
- LM Latón Mate
- NM Níquel Mate
- NS Níquel Satinado
- PL Plata



Ref.	mm	AN	CC	CI	CS	CU	LM	MR	PL	
<b>C605</b>	Ø50	8.32	14.88	8.32	14.88	8.32	8.32	8.32	17.51	10

LAT



Ref.	mm	AN	CC	CI	CS	CU	LM	MR	PL	
<b>C606</b>	Ø50	8.32	14.88	8.32	14.88	8.32	8.32	8.32	17.51	10

LAT



Ref.	mm	AN	CB	CI	CS	CU	LM	NS	PB	PL	
<b>SV-BR25</b>	Ø50	4.10	3.43	3.43	3.43	3.43	3.43	2.48	3.43	4.10	10

ZK



Ref.	mm	AN	CB	CI	CS	CU	LM	NM	PB	PL	
<b>EQ-285Z</b>	Ø50	4.10	3.43	3.43	3.43	3.43	3.43	2.48	3.43	4.10	

ZK





Ref.	mm	AN	CC	CI	CS	CU	LM	MR	PL	
<b>C608</b>	Ø50	27.36	36.45	27.36	36.45	27.36	27.36	27.36	48.87	5

LAT



Ref.	mm	AN	BL	CB	CI	CS	CU	LM	NE	NS	PB	PL	
<b>SV-CR50</b>	Ø50	10.13	8.50	8.50	8.50	8.50	8.50	8.50	8.50	6.80	8.50	10.13	2

ZK



Bocallae redonda de seguridad

Ref.	mm	AN	ANTR	BL	CB	CI	CS	CU	LM	MR	NE	NM	NMM	PB	PL	
<b>C630</b>	Ø50	6.96	6.96	8.29	8.29	8.29	8.29	8.29	8.29	19.52	8.29	8.29	6.96	8.29	6.96	10

LAT



Ref.	mm	ANTR	BL	CB	CI	CS	LM	NE	NM	NMM	PVLM	
<b>12BY</b>	Ø50	4.36	4.23	4.23	4.23	4.23	4.23	4.23	4.23	4.23	17.92	10

ZK

- AN Anticato
- ANTR Antracita
- BL Blanco
- CB Cromo Brillo
- CC Cromo Combinado
- CI Cuero Inglés
- CS Cromo Satinado
- CU Cuero
- LM Latón Mate
- MR Marrón
- NE Negro
- NM Níquel Mate
- NMM Níquel Mate Mate
- NM.OP Níq. Mat. Opaco
- NS Níquel Satinado
- PB Pulido Brillo
- PS Pulido Satin.
- PL Plata
- PVLM PVD Lat. Mate



Ref.	mm	AN	ANTR	BL	CB	CI	CS	CU	LM	NE	NMM	NS	PB	PL	PVLM	
<b>SV-495</b>	Ø35	6.80	6.80	6.38	6.38	6.38	6.38	6.38	6.38	6.38	6.38	4.60	6.38	6.80	32.38	5

ZK

JANDEL ORIGINAL





Ref.	mm	CB	CI	CS	LM	NM	PB	
<b>C611</b>	50X50	6.56	8.32	6.56	8.32	6.56	8.32	10

LAT



Ref.	mm	ANTR	BL	CB	CI	CS	LM	NE	NM	NMM	PVLM	
<b>34BY</b>	50X50	4.89	4.76	4.76	4.76	4.76	4.76	4.76	4.76	4.76	17.92	10

ZK



### Bocallae cuadrada de seguridad

Ref.	mm	ANTR	BL	CB	CI	CS	LM	NE	NM	NMM	PB	
<b>C635</b>	50X50	7.43	8.29	8.29	7.43	8.29	7.43	8.29	8.29	7.43	7.43	10

LAT



Ref.	BL	CB	CI	CS	CU	LM	NE	NM	PB	
<b>C902</b>	2.78	2.78	2.78	2.78	2.78	2.78	2.78	2.78	2.78	20

ZK

- AN Anticato
- ANTR Antracita
- BL Blanco
- CB Cromo Brillo
- CC Cromo Combinado
- CI Cuero Inglés
- CS Cromo Satinado
- CU Cuero
- LM Latón Mate
- MR Marrón
- NE Negro
- NM Níquel Mate
- NMM Níquel Mate Mate
- NM.OP Níq. Mat. Opaco
- NS Níquel Satinado
- PB Pulido Brillo
- PS Pulido Satin.
- PL Plata
- PVLM PVD Lat. Mate

JANDEL ORIGINAL



Ref.	mm	ANTR	BL	CB	CI	CS	LM	NE	NM	NMM	
<b>12WC</b>	Ø50	10.03	9.58	9.58	9.58	9.58	9.58	9.58	9.58	9.58	5

ZK



Ref.	mm	CB	CC	CI	CS	LM	NM	PB	
<b>C621</b>	Ø50	38.47	38.47	41.57	37.64	45.48	39.36	40.55	5

ZK



Ref.	mm	BL	CB	CI	CS	LM	NE	NM	NMM	
<b>34WC</b>	Ø50	11.18	11.18	11.18	11.18	11.18	11.18	11.18	11.18	5

ZK



Ref.	mm	ANTR	BL	CB	CI	CS	LM	NE	NMM	NS	
<b>SVCC35</b>	Ø35	7.95	7.45	7.45	6.80	7.45	7.45	7.45	7.45	6.35	5

ZK

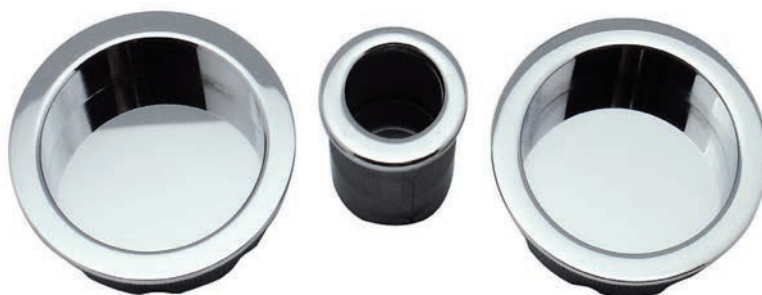

Ref.	mm	AN	ANTR	CB	CI	CS	CU	LM	MR	NM	NMOP	PB	PL	
<b>7610</b>	Ø56 Ø48 (interior)	24.96	19.59	21.45	21.73	21.45	24.96	23.57	24.96	22.47	22.18	22.24	42.85	5

ZK



Ref.	mm	ANTR	CB	CI	CS	LM	NM	NMOP	PB	
<b>7630</b>	∅56 ∅48 (interior)	20.90	26.12	24.71	26.12	27.11	34.08	24.04	26.43	5

ZK



7510



7530

Ref.	mm	AN	ANTR	BL	CB	CI	CS	CU	EFLM	LM	MR	NE	NM	NM.OP	PB	PL	
<b>7510</b>	Ø56 Ø48 (interior)	44.23	39.91	32.52	43.38	44.23	49.44	38.74	48.07	44.23	44.23	39.68	43.01	39.91	36.15	59.43	1
<b>7530</b>	56x56 Ø48 (interior)	49.49	47.30	38.82	50.79	49.49	47.93	44.36	47.30	47.31	-	50.73	51.73	47.30	44.72	74.76	1

ZK

- AN Anticato
- CB Cromo Brillo
- CS Cromo Satinado
- MR Marrón
- NMM Níquel Mate Mate
- PB Pulido Brillo
- PVLML PVD Lat. Mate
- ANTR Antracita
- CC Cromo Combinado
- CU Cuero
- NE Negro
- NM.OP Níq. Mat. Opaco
- PS Pulido Satin.
- BL Blanco
- CI Cuero Inglés
- LM Latón Mate
- NM Níquel Mate
- NS Níquel Satinado
- PL Plata



Ref.	mm	CB	CI	CS	CU	LM	NM	PB	
<b>C410</b>	129x34	14.34	13.48	14.34	13.48	13.48	14.88	12.96	10
<b>C420</b>	79x34	12.39	11.33	12.39	11.33	11.33	12.64	10.76	10

LAT



Ref.	Medidas	CI	NM	PS	
<b>C450</b>	137x33	14.88	20.55	14.88	10
<b>C460</b>	87x33	13.25	18.85	13.25	10

LAT



NEW

Ref.	mm	CI	
<b>EQ-T490</b> (porc. craquelé)	128x33	12.45	20
<b>EQ-T491</b> (porc. beige)	128x33	12.45	20
<b>EQ-T492</b> (porc. blanca)	128x33	12.45	20
<b>EQ-A490</b> (porc. craquelé)	88x33	11.16	20
<b>EQ-A491</b> (porc. beige)	88x33	11.16	20
<b>EQ-A492</b> (porc. blanca)	88x33	11.16	20

LAT

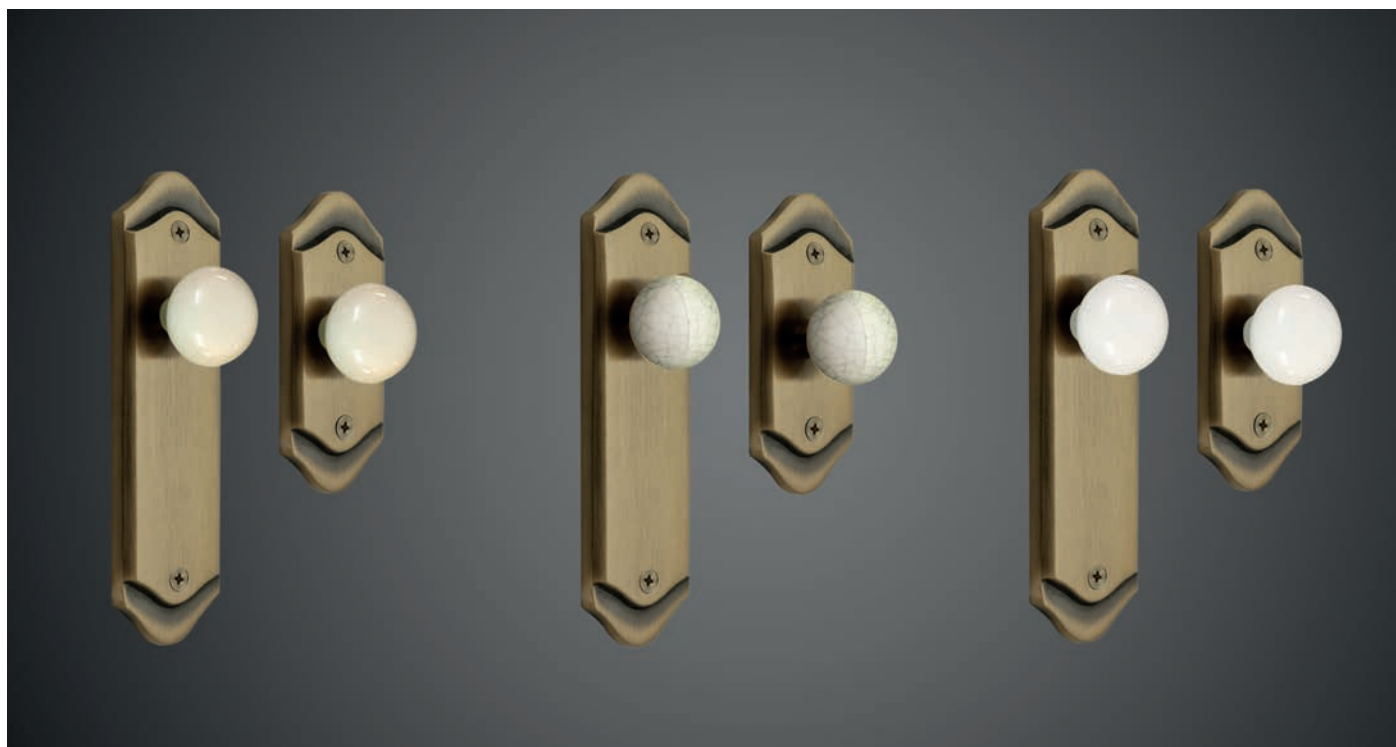

JANDEL ORIGINAL

- AN Anticato
- ANTR Antracita
- BL Blanco
- CB Cromo Brillo
- CC Cromo Combinado
- CI Cuero Inglés
- CS Cromo Satinado
- CU Cuero
- LM Latón Mate
- MR Marrón
- NE Negro
- NM Níquel Mate
- NMM Níquel Mate Mate
- NM.OP Níq. Mat. Opaco
- NS Níquel Satinado
- PB Pulido Brillo
- PS Pulido Satin.
- PL Plata
- PVL M PVD Lat. Mate

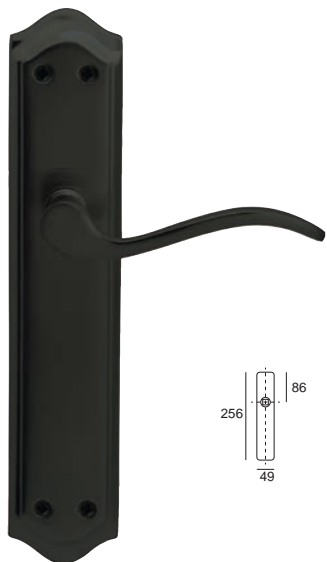

AL

Ref.	Denominación	mm	NE		
EQ-202	g o. Maniñe la	256x49	9.40	2	20
EQ-M202	Manillón	256x49	12.40	4	40
EQ-L202	Placa limpieza	256x49	4.03	10	100
EQ-C202	Asa corta c/placa	256x49	15.58	4	40
EQ-T202	Tirador armario	123x35	3.83	20	200
EQ-A202	Tirador maletero	83x35	2.78	20	200
EQ-P202	Placa pomo fijo	256x49	15.58	2	40
EQ-P202MV	Placa pomo móv l	256x49	16.43	2	40

AL

Ref.	Denominación	mm	PS		
EQ-203	g o. Maniñe la	256x49	8.95	2	20
EQ-M203	Manillón	256x49	12.40	4	40
EQ-L203	Placa limpieza	256x49	4.03	10	100
EQ-C203	Asa corta c/placa	256x49	12.40	4	40
EQ-T203	Tirador armario	123x35	3.83	20	200
EQ-A203	Tirador maletero	83x35	2.78	20	200
EQ-P203	Placa pomo fijo	256x49	15.58	2	40
EQ-P203MV	Placa pomo móv l	256x49	16.43	2	40

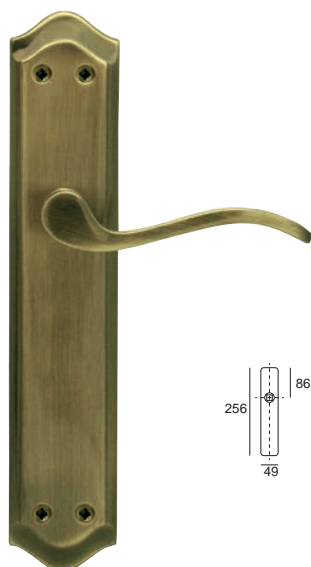

AL

Ref.	Denominación	mm	CU		
EQ-204	g o. Maniñe la	256x49	9.50	2	20
EQ-M204	Manillón	256x49	12.40	4	40
EQ-L204	Placa limpieza	256x49	4.03	10	100
EQ-C204	Asa corta c/placa	256x49	12.40	4	40
EQ-T204	Tirador armario	123x35	3.83	20	200
EQ-A204	Tirador maletero	83x35	2.78	20	200
EQ-P204	Placa pomo fijo	256x49	15.58	2	40
EQ-P204MV	Placa pomo móv l	256x49	16.43	2	40

AL

Ref.	Denominación	mm	NS		
EQ-205	g o. Maniñe la	256x49	9.18	2	20
EQ-M205	Manillón	256x49	12.40	4	40
EQ-L205	Placa limpieza	256x49	4.03	10	100
EQ-C205	Asa corta c/placa	256x49	12.40	4	40
EQ-T205	Tirador armario	123x35	3.83	20	200
EQ-A205	Tirador maletero	83x35	2.78	20	200
EQ-P205	Placa pomo fijo	256x49	15.58	2	40
EQ-P205MV	Placa pomo móv l	256x49	16.43	2	40



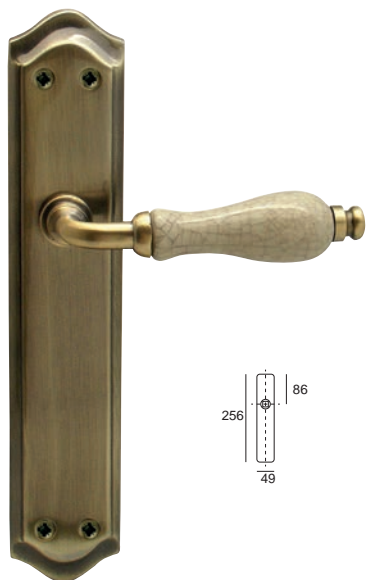

AL / LAT

Ref.	Denom.	AN	CI	CU	NS	PL	PS		
EQ-206	g o. Man. CRAQUELÉ	35.25	33.90	33.90	33.90	35.25	33.40	1	20
	g o. Man. BEIGE	35.25	33.90	33.90	33.90	35.25	33.40	1	20
	g o. Man. BLANCA	35.25	33.90	33.90	33.90	35.25	33.40	1	20
EQ-T290	Tirador armario CRAQUELÉ	10.05	9.63	9.63	9.63	10.05	9.63	20	200
EQ-T291	Tirador armario BEIGE	9.85	9.45	9.45	9.45	9.85	9.45	20	200
EQ-T292	Tirador armario BLANCA	9.85	9.45	9.45	9.45	9.85	9.45	20	200
EQ-A290	Tirador malet. CRAQUELÉ	9.63	9.25	9.25	9.25	9.63	9.25	20	200
EQ-A291	Tirador malet. BEIGE	9.45	9.05	9.05	9.05	9.45	9.05	20	200
EQ-A292	Tirador malet. BLANCA	9.45	9.05	9.05	9.05	9.45	9.05	20	200

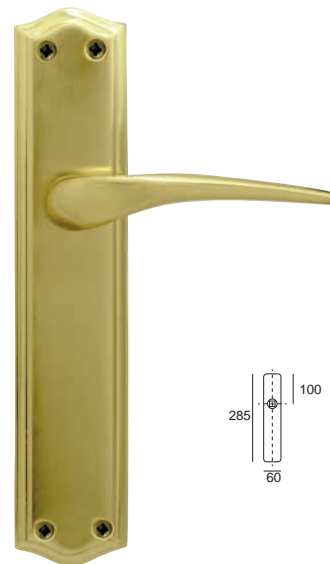

ZK

Ref.	Denominación	mm	PS		
EQ-207	g o. Maniñe la	285x60	23.02	1	20
EQ-M207	Manillón	285x60	16.68	2	40
EQ-L207	Placa limpieza	285x60	7.08	10	100
EQ-C207	Asa corta c/placa	285x60	16.68	4	40
EQ-T203	Tirador armario	123x35	3.83	20	200
EQ-A203	Tirador maletero	83x35	2.78	20	200
EQ-P207	Placa pomo fijo	285x60	16.68	2	40
EQ-P207MV	Placa pomo móv l	285X60	17.48	2	40

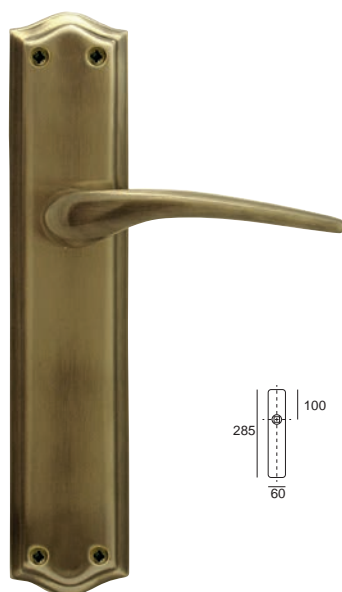

ZK

Ref.	Denominación	mm	CU		
EQ-208	g o. Maniñe la	285x60	23.02	1	20
EQ-M208	Manillón	285x60	16.68	2	40
EQ-L208	Placa limpieza	285x60	7.08	10	100
EQ-C208	Asa corta c/placa	285x60	16.68	4	40
EQ-T204	Tirador armario	123x35	3.83	20	200
EQ-A204	Tirador maletero	83x35	2.78	20	200
EQ-P208	Placa pomo fijo	285x60	16.68	2	40
EQ-P208MV	Placa pomo móv l	285X60	17.48	2	40



ZK

Ref.	Denominación	mm	NS		
EQ-209	g o. Maniñe la	285x60	23.02	1	20
EQ-M209	Manillón	285x60	16.68	2	40
EQ-L209	Placa limpieza	285x60	7.08	10	100
EQ-C209	Asa corta c/placa	285x60	16.68	4	40
EQ-T205	Tirador armario	123x35	3.83	20	200
EQ-A205	Tirador maletero	83x35	2.78	20	200
EQ-P209	Placa pomo fijo	285x60	16.68	2	40
EQ-P209MV	Placa pomo móv l	285X60	17.48	2	40

- AN Anticato
- CB Cromo Brillo
- CS Cromo Satinado
- NMM Niq. Mate Mate
- PB Pulido Brillo
- ANTR Antracita
- CI Cuero Inglés
- LM Latón Mate
- NS Níquel Satinado
- PL Plata
- BL Blanco
- CU Cuero
- NE Negro
- NS/NB Niq. Sat / Niq. Br.
- PS Pulido Satin.



JANDEL EQUAL

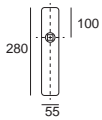

ZK

Ref.	Denominación	mm	CU	NS	PS		
EQ-210	g o. Manillón	280x55	24.02	24.02	24.02	1	20
EQ-M210	Manillón	280x55	16.93	16.93	16.93	2	40
EQ-L210	Placa limpieza	280x55	7.08	7.08	7.08	10	100
EQ-C210	Asa corta c/placa	280x55	16.93	16.93	16.93	4	40
EQ-P210	Placa pomo fijo	280x55	16.93	16.93	16.93	2	40
SV-T150	Tirador armario	129x34	4.68	4.68	4.68	20	200
SV-A150	Tirador maletero	79x34	3.85	3.85	3.85	20	200
EQ-P210MV	Placa pomo móvil	280x55	17.48	17.48	17.48	2	40

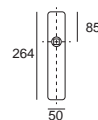

AL

Ref.	Denominación	mm	CI	NS	PS		
EQ-868	g o. Manillón	264x50	11.23	11.23	11.23	2	20
EQ-M868	Manillón	264x50	12.40	12.40	12.40	2	40
EQ-L868	Placa limpieza	264x50	7.08	7.08	7.08	10	100
EQ-C868	Asa corta c/placa	264x50	12.40	12.40	12.40	4	40
EQ-T203	Tirador armario	125x35	3.83	3.83	3.83	20	200
EQ-A203	Tirador maletero	83x35	2.78	2.78	2.78	20	200
EQ-P868	Placa pomo fijo	264x50	17.10	17.10	17.10	2	40
EQ-P868MV	Placa pomo móvil	264x50	17.90	17.90	17.90	2	40



- |                  |                   |                     |                             |                    |
|------------------|-------------------|---------------------|-----------------------------|--------------------|
| ● AN Anticato    | ● CB Cromo Brillo | ● CS Cromo Satinado | ● NMM Níq. Mate Mate        | ● PB Pulido Brillo |
| ● ANTR Antracita | ● CI Cuero Inglés | ● LM Latón Mate     | ● NS Níquel Satinado        | ● PL Plata         |
| ○ BL Blanco      | ● CU Cuero        | ● NE Negro          | ● NS/NB Níq. Sat / Níq. Br. | ● PS Pulido Satin. |

JANDEL EQUAL





**EQ-R150** AL

mm	CU	LM	NE	NS	PB		
Ø 50	9.08	8.55	8.05	6.13	8.55	1	20



**EQ-R200** AL

mm	BL	LM	NE	NS	NS/NB		
Ø 50	8.55	8.55	8.05	6.13	9.50	1	20



**EQ-R204** AL

mm	CU		
Ø 50	9.50	1	20



**SV-R250** AL

mm	NS/NB		
Ø 50	8.55	1	20

JANDEL EQUAL

- AN Anticato
- ANTR Antracita
- BL Blanco

- CB Cromo Brillo
- CI Cuero Inglés
- CU Cuero



- CS Cromo Satinado
- LM Latón Mate
- NE Negro

- NMM Níq. Mate Mate
- NS Níquel Satinado
- NS/NB Níq. Sat / Níq. Br.

- PB Pulido Brillo
- PL Plata
- PS Pulido Satin.





**SV-R300** AL

mm	NS		
Ø 50	8.55	1	20





**SV-R333** AL

mm	LM	NE		
Ø 50	12.60	12.60	1	20





**SV-R350** AL

mm	NS/NB		
Ø 50	8.55	1	20



**SV-R600** AL

mm	ANTR	BL	NE	NS	NS/ NB		
Ø 50	12.03	11.90	11.90	10.28	11.90	1	20



NEW

**SV-R700** AL

mm	ANTR	NE	NS		
Ø 50	13.45	11.98	10.48	1	20

**SV-R800** AL

mm	NS		
Ø 50	11.02	1	20



NEW

**SV-R850** AL

mm	ANTR	LM	NE	NS		
Ø 50	13.15	11.70	11.70	9.98	1	20

NEW

Tapa Pomos

**EQ-R655** AL

mm	CU	LM	NE	NS	PB		
Ø 65	13.25	13.25	13.25	13.25	13.25	1	20

● AN Anticato  
● ANTR Antracita  
○ BL Blanco

● CB Cromo Brillo  
● CI Cuero Inglés  
● CU Cuero

● CS Cromo Satinado  
● LM Latón Mate  
● NE Negro



● NMM Níq. Mate Mate  
● NS Níquel Satinado  
● NS/NB Níq. Sat / Níq. Br.

● PB Pulido Brillo  
● PL Plata  
● PS Pulido Satin.

NEW





**EQ-C150** AL

mm	NS		
50x50	10.70	1	20





**SV-C200** AL

mm	NE	NS		
50x50	11.45	10.33	1	20

NEW





**SV-C350** AL

mm	NS/NB		
50x50	10.43	1	20



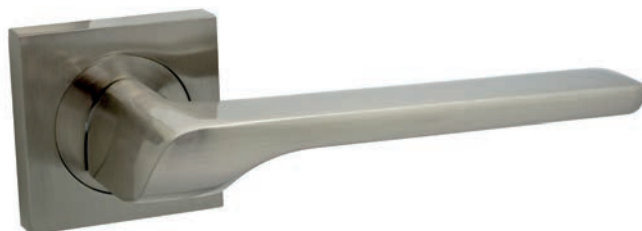

**SV-C400** AL

mm	ANTR	BL	LM	NE	NS	NS/NB		
50x50	12.05	12.20	12.20	12.20	10.78	12.20	1	20





**SV-C700** AL

mm	NE	NS		
50x50	15.03	13.83	1	20



**SV-C750** AL

mm	NS		
50x50	15.08	1	20





JANDEL EQUAL

- |                  |                   |                     |                             |                    |
|------------------|-------------------|---------------------|-----------------------------|--------------------|
| ● AN Anticato    | ● CB Cromo Brillo | ● CS Cromo Satinado | ● NMM Níq. Mate Mate        | ● PB Pulido Brillo |
| ● ANTR Antracita | ● CI Cuero Inglés | ● LM Latón Mate     | ● NS Níquel Satinado        | ● PL Plata         |
| ○ BL Blanco      | ● CU Cuero        | ● NE Negro          | ● NS/NB Níq. Sat / Níq. Br. | ● PS Pulido Satin. |

MANILLAS EN NEGRO



EQ-R150



SV-R700



EQ-R200



SV-R850



SV-R333



SV-C200



SV-R600



SV-C400



SV-R655



SV-C700

## MANILLAS EN LATÓN MATE



EQ-R150



EQ-R200



SV-C400



SV-R850

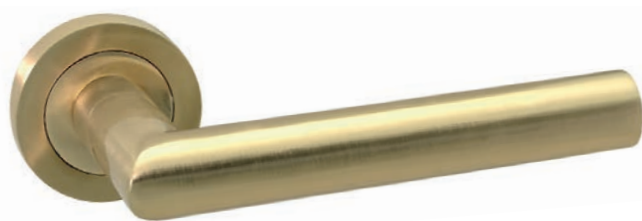

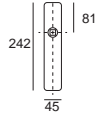

SV-R333

- |                  |                   |                     |                             |                    |
|------------------|-------------------|---------------------|-----------------------------|--------------------|
| ● AN Anticato    | ● CB Cromo Brillo | ● CS Cromo Satinado | ● NMM Níq. Mate Mate        | ● PB Pulido Brillo |
| ● ANTR Antracita | ● CI Cuero Inglés | ● LM Latón Mate     | ● NS Níquel Satinado        | ● PL Plata         |
| ○ BL Blanco      | ● CU Cuero        | ● NE Negro          | ● NS/NB Níq. Sat / Níq. Br. | ● PS Pulido Satin. |



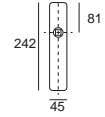

AL

Ref.	CU	LM	NE	NS	PB		
<b>SV-P150</b>	9.88	9.88	9.88	8.80	9.88	2	20





AL

Ref.	BL	LM	NE	NS		
<b>SV-P200</b>	11.95	10.90	10.90	9.10	2	20

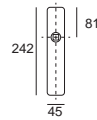
JANDEL EQUAL



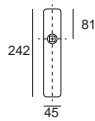

AL

Ref.	NS/NB		
<b>SV-P250</b>	12.95	2	20



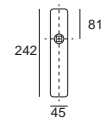
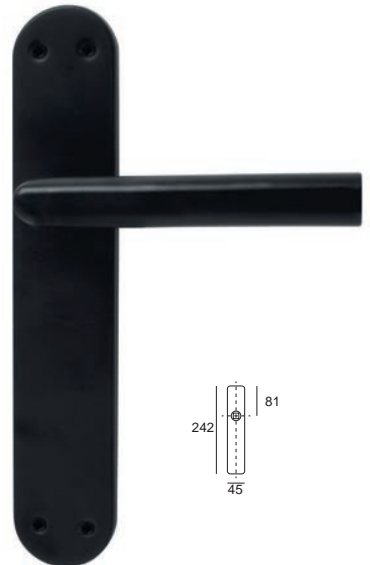

AL

Ref.	NS		
<b>SV-P300</b>	12.95	2	20



AL

Ref.	LM	NE		
<b>SV-P333</b>	15.38	15.38	1	20

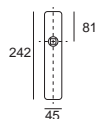

AL

Ref.	NS/NB		
<b>SV-P350</b>	12.95	2	20

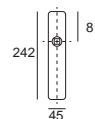

AL

Ref.	ANTR	BL	NE	NS		
<b>SV-P600</b>	17.40	14.68	14.68	12.95	1	20

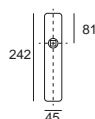

NEW

AL

Ref.	ANTR	LM	NE	NS		
<b>SV-P850</b>	17.40	15.30	15.13	12.98	1	20

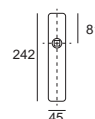

NEW

AL

Ref.	ANTR	NE	NS		
<b>SV-P700</b>	17.40	14.90	14.03	1	20



JANDEL EQUAL



- AN Anticato
- CB Cromo Brillo
- CS Cromo Satinado
- NMM Niq. Mate Mate
- PB Pulido Brillo
- ANTR Antracita
- CI Cuero Inglés
- LM Latón Mate
- NS Níquel Satinado
- PL Plata
- BL Blanco
- CU Cuero
- NE Negro
- NS/NB Niq. Sat / Niq. Br.
- PS Pulido Satin.





AL

Ref.	NE	NS		
<b>SV-PC20</b>	14.30	12.95	1	20

NEW



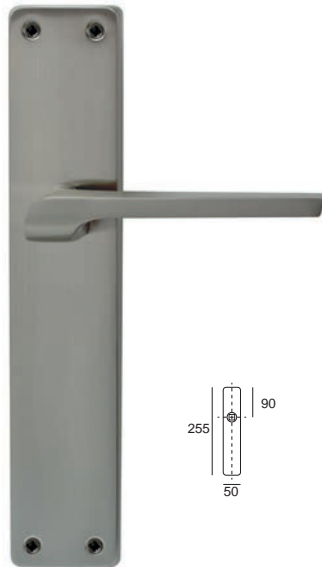

AL

Ref.	NS/NB		
<b>SV-PC35</b>	15.13	1	20





AL

Ref.	NE	NS		
<b>SV-PC70</b>	16.28	15.53	1	20





AL

Ref.	NS		
<b>SV-PC75</b>	15.53	1	20



AL

Ref.	ANTR	BL	LM	NE	NS	NS/NB		
<b>SV-P400</b>	17.93	16.83	16.83	16.83	15.83	16.40	1	20

JANDEL EQUAL



JANDEL EQUAL

● AN Anticato  
● ANTR Antracita  
○ BL Blanco

● CB Cromo Brillo  
● CI Cuero Inglés  
● CU Cuero

● CS Cromo Satinado  
● LM Latón Mate  
● NE Negro

● NMM Níq. Mate Mate  
● NS Níquel Satinado  
● NS/NB Níq. Sat / Níq. Br.

● PB Pulido Brillo  
● PL Plata  
● PS Pulido Satin.

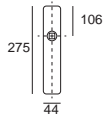

ZK

Ref.	NE		
<b>SV-P398</b>	14.23	1	20

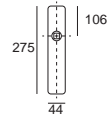

ZK

Ref.	NE		
<b>SV-P500</b>	12.95	1	20

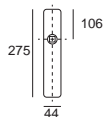

ZK

Ref.	NE		
<b>SV-PP50</b>	13.38	2	40

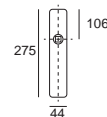

ZK

Ref.	NE		
<b>SV-M500</b>	9.68	5	40







- |                  |                   |                     |                             |                    |
|------------------|-------------------|---------------------|-----------------------------|--------------------|
| ● AN Anticato    | ● CB Cromo Brillo | ● CS Cromo Satinado | ● NMM Níq. Mate Mate        | ● PB Pulido Brillo |
| ● ANTR Antracita | ● CI Cuero Inglés | ● LM Latón Mate     | ● NS Níquel Satinado        | ● PL Plata         |
| ○ BL Blanco      | ● CU Cuero        | ● NE Negro          | ● NS/NB Níq. Sat / Níq. Br. | ● PS Pulido Satin. |



AL

Ref.	mm (centr.)	CU	LM	NE	NS	PB	
<b>SV-M150</b>	200	10.90	10.90	10.90	10.68	10.90	1

AL

Ref.	mm (centr.)	NS/NB	
<b>SV-M350</b>	180	12.90	1

JANDEL EQUAL



AL

Ref.	mm (centr.)	BL	LM	NE	NS	NS/NB	
<b>SV-M200</b>	200	10.90	10.90	10.90	10.68	12.90	1



Ref.	mm (entre cent.)	NE	
<b>EQ-M802</b> (Ø 25)	225 (200)	29.03	2
	325 (300)	32.91	2
	625 (600)	43.44	2
	925 (900)	57.06	2
	1225 (1200)	70.71	2

AL

INOX

Ref.	mm (centr.)	ANTR	BL	CB	CS	LM	NE	NS	
<b>SV-M335</b>	200	13.80	13.80	13.80	13.80	13.80	13.80	13.80	1



AL

Ref.	mm (centr.)	BL	NE	NS	
<b>SV-M600</b>	200	16.15	16.15	16.15	1

- AN Anticato
- ANTR Antracita
- BL Blanco

- CB Cromo Brillo
- CI Cuero Inglés
- CU Cuero

- CS Cromo Satinado
- LM Latón Mate
- NE Negro

- NMM Níq. Mate Mate
- NS Níquel Satinado
- NS/NB Níq. Sat / Níq. Br.

- PB Pulido Brillo
- PL Plata
- PS Pulido Satin.



NEW

AL

Ref.	mm (centr.)	NS	
<b>SV-MC15</b>	200	14.50	1



AL

Ref.	mm (centr.)	NE	NS	
<b>SV-MC20</b>	200	15.50	14.68	1



NEW

AL

Ref.	mm (centr.)	NS/NB	
<b>SV-MC35</b>	200	16.72	1



AL

Ref.	mm (centr.)	BL	NE	NS	NS/NB	
<b>SV-M400</b>	200	18.75	18.75	18.75	18.75	1



JANDEL EQUAL

- |                  |                   |                     |                             |                    |
|------------------|-------------------|---------------------|-----------------------------|--------------------|
| ● AN Anticato    | ● CB Cromo Brillo | ● CS Cromo Satinado | ● NMM Níq. Mate Mate        | ● PB Pulido Brillo |
| ● ANTR Antracita | ● CI Cuero Inglés | ● LM Latón Mate     | ● NS Níquel Satinado        | ● PL Plata         |
| ○ BL Blanco      | ● CU Cuero        | ● NE Negro          | ● NS/NB Níq. Sat / Níq. Br. | ● PS Pulido Satin. |

\* Medidas especiales consultar con el departamento comercial



INOX

Ref.	A (B)	NE	
<b>EQ-M800</b> Ø30 mm	300 (210)	36.40	2
	400 (300)	40.78	2
	500 (300)	44.65	2
	600 (400)	51.80	2
	800 (600)	60.65	2
	1200 (900)	77.18	2
	1500 (1300)	91.90	1
	1800 (1500)	109.55	1



INOX

Ref.	A (B)	NE	
<b>EQ-M810</b> Ø30 mm Desplaz do 45°	300 (210)	45.61	2
	400 (300)	50.68	2
	500 (300)	56.85	2
	600 (400)	64.05	2
	800 (600)	77.53	2
	1200 (900)	108.53	2

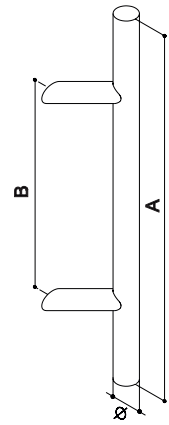

INOX

Ref.	A (B)	NE	
<b>EQ-M831</b> ■25 x 25 mm	300 (210)	36.40	2
	400 (300)	40.78	2
	500 (300)	44.65	2
	600 (400)	51.80	2
	800 (600)	60.65	2
	1200 (900)	77.18	2
	1500 (1300)	91.90	1
	1800 (1500)	109.55	1

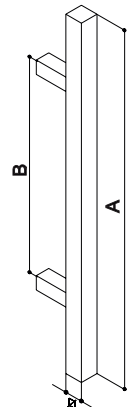

NEW

INOX

Ref.	A (B)	NE	
<b>EQ-M861</b> ■25 x 25 mm Desplaz do 45°	400 (210)	50.68	1
	500 (300)	56.85	1
	600 (400)	64.05	1
	700 (500)	70.28	1
	800 (600)	77.53	1
	1200 (900)	108.53	1

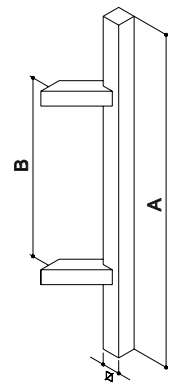



- |                  |                   |                     |                             |                    |
|------------------|-------------------|---------------------|-----------------------------|--------------------|
| ● AN Anticato    | ● CB Cromo Brillo | ● CS Cromo Satinado | ● NMM Níq. Mate Mate        | ● PB Pulido Brillo |
| ● ANTR Antracita | ● CI Cuero Inglés | ● LM Latón Mate     | ● NS Níquel Satinado        | ● PL Plata         |
| ○ BL Blanco      | ● CU Cuero        | ● NE Negro          | ● NS/NB Níq. Sat / Níq. Br. | ● PS Pulido Satin. |

JANDEL EQUAL



JANDEL EQUAL





INOX



Ref.	A (B)	NE	
<b>SV-M360</b> (■ 20)	220 (200)	22.93	2
	270 (250)	24.53	2
	320 (300)	26.38	2
	420 (400)	28.73	2
	470 (450)	30.88	2









NEW



INOX

Ref.	A (B)	NE	
<b>EQ-M802K</b> (■ 25)	225 (200)	27.90	2
	325 (300)	30.13	2
	625 (600)	39.45	2
	925 (900)	51.53	2
	1225 (1200)	63.70	2

-  AN Anticato
-  ANTR Antracita
-  BL Blanco

-  CB Cromo Brillo
-  CI Cuero Inglés
-  CU Cuero

-  CS Cromo Satinado
-  LM Latón Mate
-  NE Negro

-  NMM Níq. Mate Mate
-  NS Níquel Satinado
-  NS/NB Níq. Sat / Níq. Br.

-  PB Pulido Brillo
-  PL Plata
-  PS Pulido Satin.



SV-C150



SV-MP15



SV-PP15

JANDEL EQUAL

Ref.	mm	BL	CU	LM	NE	NS	PB	
SV-C150	242x45	16.40	16.40	16.40	16.40	16.40	16.40	2
SV-MP15	242x45	16.40	16.40	16.40	16.40	16.40	16.40	2
SV-PP15	242x45	19.78	19.78	19.78	19.78	19.78	19.78	2

AL / LAT



JANDEL EQUAL

- |                  |                   |                     |                             |                    |
|------------------|-------------------|---------------------|-----------------------------|--------------------|
| ● AN Anticato    | ● CB Cromo Brillo | ● CS Cromo Satinado | ● NMM Níq. Mate Mate        | ● PB Pulido Brillo |
| ● ANTR Antracita | ● CI Cuero Inglés | ● LM Latón Mate     | ● NS Níquel Satinado        | ● PL Plata         |
| ○ BL Blanco      | ● CU Cuero        | ● NE Negro          | ● NS/NB Níq. Sat / Níq. Br. | ● PS Pulido Satin. |



ZK

Ref.	Ø mm	ANTR	BL	CU	LM	NE	NM	PB	
<b>EQ-285Z</b>	50	3.43	3.43	3.43	3.43	3.43	2.48	3.43	10

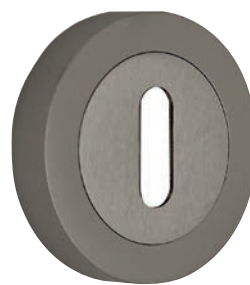

ZK

Ref.	Ø mm	ANTR	BL	CU	LM	NE	NS	PB	
<b>SV-BR25</b>	50	3.43	3.43	3.43	3.43	3.43	2.48	3.43	10

INOX

Ref.	Ø mm	NE	
<b>SV-B304</b>	52	2.75	10
<b>SV-B305</b>	52	2.75	10



ZK

Ref.	Ømm	ANTR	BL	CU	LM	NE	NS	PB	
<b>SV-CR50</b>	50	8.50	8.50	8.50	8.50	8.50	6.80	8.50	2

ZK

Ref.	Ømm	ANTR	BL	CU	LM	NE	NMM	NS	PB	
<b>SV-495</b>	35	6.80	6.38	6.38	6.38	6.38	6.38	4.60	6.38	5

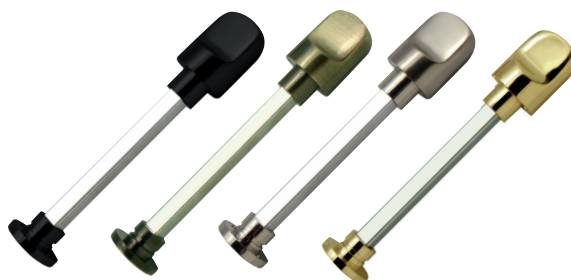

ZK

Ref.	AN	ANTR	BL	CI	CS	CU	LM	NE	NMM	NS	PB	PL	
<b>EQ-1197</b>	3.05	3.05	3.05	3.05	3.05	3.05	3.05	3.05	3.05	3.05	3.05	3.05	10



ZK

Ref.	mm	ANTR	BL	CB	CS	NE	NS	NS/NB	
<b>SV-BC15</b>	50x50	3.58	3.58	3.58	3.58	3.58	3.58	3.58	10
<b>SV-BC25</b>	50x50	4.25	4.25	4.25	4.25	4.25	4.25	-	10



INOX

Ref.	mm	NE	
<b>SV-B303</b>	50x50	2.78	10
<b>SV-B308</b>	50x50	2.43	10

ZK

Ref.	mm	ANTR	BL	CB	CI	CS	LM	NE	NMM	NS	
<b>SV-CC35</b>	35x35	7.95	7.45	7.45	6.80	7.45	7.45	7.45	7.45	6.35	5



ZK

Ref.	mm	ANTR	BL	CB	CS	NE	NS	NS/NB	
<b>SV-CC50</b>	50x50	9.83	9.83	9.83	9.83	9.83	8.55	9.83	2



ZK

Ref.	BL	CB	CI	CS	CU	LM	NE	NS	PB	
<b>C902</b>	2.78	2.78	2.78	2.78	2.78	2.78	2.78	2.78	2.78	20

● AN Anticato  
● ANTR Antracita  
○ BL Blanco

● CB Cromo Brillo  
● CI Cuero Inglés  
● CU Cuero

● CS Cromo Satinado  
● LM Latón Mate  
● NE Negro

● NMM Níq. Mate Mate  
● NS Níquel Satinado  
● NS/NB Níq. Sat / Níq. Br.



● PB Pulido Brillo  
● PL Plata  
● PS Pulido Satin.



ZK

Ref.	BL	CB	CS	NE	NS	PB	
SVDEDALC	1.68	1.68	1.68	1.68	1.68	-	20
SVDEDALR	1.68	1.68	1.68	1.68	1.68	1.68	20



ZK

Ref.	ANTR	BL	CB	CS	CU	LM	NE	NS	PB		
SV-CCDR	6.05	5.70	5.70	5.70	5.70	5.70	5.70	5.40	5.70	1	20

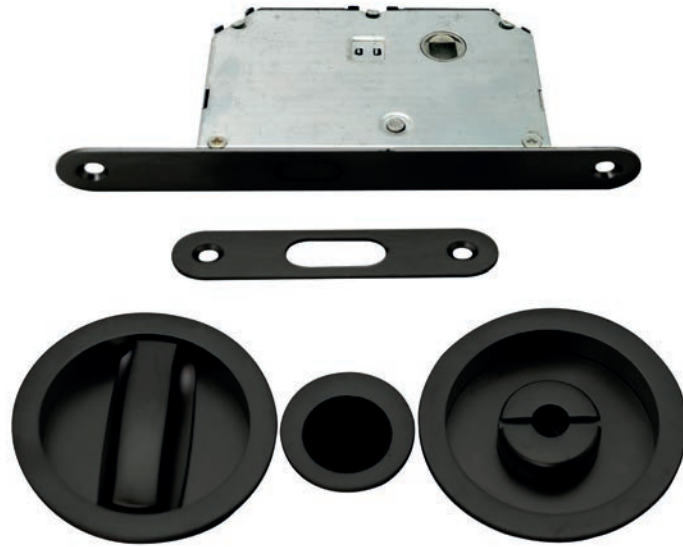
Ø56 mm (Ø48 interior)





ZK

Ref.	ANTR	BL	CB	CS	CU	LM	NE	NS	PB		
SV-KITR	12.95	12.53	12.53	12.53	12.53	12.53	12.53	10.48	12.53	1	20

Ø56 mm (Ø48 interior)  
Frontal **16 mm.**



ZK

Ref.	BL	CB	CS	CU	LM	NE	NS	PB		
KITR20	15.30	15.30	15.30	15.30	15.30	15.30	14.13	15.30	1	20

Ø56 mm (Ø48 interior)  
Frontal **20 mm.** Especial para picaporte unificado de 70 mm.

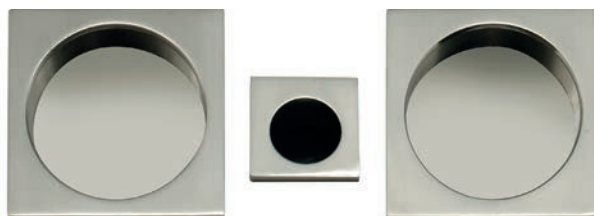

ZK

Ref.	ANTR	BL	CB	CS	LM	NE	NS		
<b>SV-CCDC</b>	6.65	6.05	6.05	6.05	6.05	6.05	5.68	1	20

56 x 56 mm (Ø48 interior)



ZK

Ref.	ANTR	BL	CB	CS	LM	NE	NS		
<b>SV-KITC</b>	13.35	12.75	12.75	12.75	12.75	12.75	12.55	1	20

56 x 56 (Ø48 interior)  
Frontal **16 mm.**



**NEW**

ZK

ZK

Ref.	BL	CB	CS	NE	NS		
<b>KITC20</b>	13.90	13.90	13.90	13.90	13.63	1	20

56 x 56 mm (Ø48 interior)  
Frontal **20 mm.** Especial para picaporte unificado de 70 mm.

Ref.	NS	
<b>PICOLORO</b>	7.50	10

- AN Anticato
- CB Cromo Brillo
- CS Cromo Satinado
- NMM Níq. Mate Mate
- PB Pulido Brillo
- ANTR Antracita
- CI Cuero Inglés
- LM Latón Mate
- NS Níquel Satinado
- PL Plata
- BL Blanco
- CU Cuero
- NE Negro
- NS/NB Níq. Sat / Níq. Br.
- PS Pulido Satin.



Kits corredera con bombillo 40 mm con 3 llaves



ZK

Ref.	mm	CU	NE	NS	PB	
<b>SV-KITB</b>	Ø56 (Ø48 int.)	25.70	25.70	25.70	25.70	1

ZK

Ref.	mm	CB	CS	NE	NS	
<b>SV-KITBC</b>	■ 56 (Ø48 int.)	29.60	29.60	29.60	29.60	1

JANDEL EQUAL



ZK

Ref.	mm	ANTR	BL	CU	NE	NS	PB	
<b>PU-47</b>	47	4.75	4.35	4.35	4.35	4.10	4.35	10
<b>PU-70</b>	70	6.35	5.85	5.85	5.85	4.55	5.85	10

ZK

Ref.	mm	CU	LM	NE	NS	
<b>SV-PSMN</b>	Ø70	7.20	7.20	7.20	6.93	15





ZK

Ref.	Ø mm	MIXTA	NS	PB	
<b>MR-2542</b>	14(25-42)	2.04	2.04	2.04	12

\*Se suministran por cajas



ZK

Ref.	Ø mm	MIXTA	NE	NS	PB	
<b>MR-3560</b>	14(35-60)	2.38	2.38	2.38	2.38	12

\*Se suministran por cajas



ZK

Ref.	Ø mm	NE	NS	
<b>SV-TOPE</b>	22x30	3.98	3.98	25



AL

Ref.	mm	ANTR	BL	CB	CI	CS	CU	LM	NE	NS	PB	
<b>SV-T150</b>	129x34	5.28	4.68	4.68	4.68	4.68	4.68	4.68	4.68	4.68	4.68	20
<b>SV-A150</b>	79x34	4.45	3.85	3.85	3.85	3.85	3.85	3.85	3.85	3.85	3.85	20



AL

Ref.	mm	ANTR	BL	CB	CI	CS	LM	NE	NS	PB	
<b>SV-T401</b>	132x38	5.28	4.68	4.68	4.68	4.68	4.68	4.68	4.68	4.68	20
<b>SV-A401</b>	81x34	4.45	3.85	3.85	3.85	3.85	3.85	3.85	3.85	3.85	20

● AN Anticato  
● ANTR Antracita  
○ BL Blanco

● CB Cromo Brillo  
● CI Cuero Inglés  
● CU Cuero

● CS Cromo Satinado  
● LM Latón Mate  
● NE Negro

● NMM Niq. Mate Mate  
● NS Níquel Satinado  
● NS/NB Niq. Sat / Niq. Br.

● PB Pulido Brillo  
● PL Plata  
● PS Pulido Satin.



ZK

Ref.	mm	ANTR	BL	CU	NE	NS	PB		
<b>PH-100D</b>	100x57x2	1.68	1.20	1.20	1.20	1.20	1.20	20	240
<b>PH-100I</b>	100x57x2	1.68	1.20	1.20	1.20	1.20	1.20	20	240

\*Se suministran por cajas



ZK

Ref.	mm	BL	CU	NE	NS	PB		
<b>PH-95D</b>	95x54x2	1.20	1.20	1.20	1.20	1.20	20	240
<b>PH-95I</b>	95x54x2	1.20	1.20	1.20	1.20	1.20	20	240

\*Se suministran por cajas



INOX

Ref.	mm	INOX		
<b>PI-100D</b>	100x57x2	1.70	20	240
<b>PI-100I</b>	100x57x2	1.70	20	240

\*Se suministran por cajas



INOX

Ref.	mm	INOX		
<b>PI-95D</b>	95x53x2	1.70	20	240
<b>PI-95I</b>	95x53x2	1.70	20	240

\*Se suministran por cajas



ZK

Ref.	mm	BL	CU	LM	NE		
<b>BH-90CD</b>	90x65x2.5	2.20	2.20	2.20	2.20	10	100
<b>BH-90CI</b>	90x65x2.5	2.20	2.20	2.20	2.20	10	100
<b>BH-80CD</b>	80x60x2.5	-	2.25	2.25	2.25	10	100
<b>BH-80CI</b>	80x60x2.5	-	2.25	2.25	2.25	10	100

\*Se suministran por cajas



ZK

Ref.	mm	BL	CU	LM	NE		
<b>BH-90RD</b>	90x65x2.5	2.20	2.20	2.20	2.20	10	100
<b>BH-90RI</b>	90x65x2.5	2.20	2.20	2.20	2.20	10	100

\*Se suministran por cajas



INOX

Ref.	mm	INOX		
<b>BI-90CD</b>	90x65x2.5	2.48	10	100
<b>BI-90CI</b>	90x65x2.5	2.48	10	100
<b>BI-80CD</b>	80x60x2.5	2.53	10	100
<b>BI-80CI</b>	80x60x2.5	2.53	10	100

\*Se suministran por cajas



INOX

Ref.	mm	INOX		
<b>BI-90RD</b>	90x65x2.5	2.48	10	100
<b>BI-90RI</b>	90x65x2.5	2.48	10	100

\*Se suministran por cajas

- AN Anticato
- CB Cromo Brillo
- CS Cromo Satinado
- NMM Níq. Mate Mate
- PB Pulido Brillo
- ANTR Antracita
- CI Cuero Inglés
- LM Latón Mate
- NS Níquel Satinado
- PL Plata
- BL Blanco
- CU Cuero
- NE Negro
- NS/NB Níq. Sat / Níq. Br.
- PS Pulido Satin.

JANDEL EQUAL



NEW

AL

Ref.	mm	NE	NS	
<b>SV-PR</b>	242x45	5.05	5.05	10



NEW

AL

Ref.	mm	NE	NS	
<b>SV-PC</b>	255x50	5.68	5.68	10

● **PB** Pulido Brillo  
● **PS** Pulido Satin.  
● **NS** Níquel Satin.

● **CU** Cuero  
● **CI** Cuero Inglés  
● **CB** Cromo Brillo

● **NS/NB** Níq. Sat / Níq. Br  
● **LM** Latón Mate  
● **NE** Negro

○ **BL** Blanco  
● **CS** Cromo Satinado  
● **PL** Plata

● **AN** Anticato  
● **NMM** Níq. Mate Mate

## Accesorios Técnicos

\*Taladro condena y desbloqueo 1€ Neto

\*Taladro bocallave 0,50€ Neto

\*Taladro bocallave cortinilla 2,50€ Neto



8X8
3.80

Fijación expositor cuadradillo



Ø8
3.80

Fijación expositor roscado pomo



8x85	8x120	8x150	8x200
0.92	1.16	1.96	6.90

Cuadradillo fresado de 8 mm



6x80	6x100	6x120
0.74	0.92	1.62

Cuadradillo fresado de 6 mm



de 7 a 6	de 8 a 6	de 8 a 7
0.52	0.52	0.52

Reductor



8x65	8x85
4.20	4.20

Cuadradillo de expansión



Muelle
0.70



Muelle espiral

# LINEA INOX



ELEVADA RESISTENCIA  
A LA CORROSIÓN

JANDEL INOX





Ref.	mm	INOX	NE		
<b>SV-R302</b>	Ø 52	7.43	11.60	1	20





Ref.	mm	INOX		
<b>SV-X302</b>	60x32	10.20	1	20





Ref.	mm	INOX		
<b>SV-F302</b>	170x170	28.05	1	10



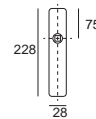

Ref.	mm	INOX		
<b>SV-G302</b>	60x32	8.23	2	20



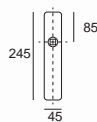

Ref.	INOX		
<b>SV-E302</b>	19.10	2	20



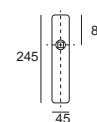

Ref.	INOX		
<b>SV-P301</b>	18.45	1	20





Ref.	INOX	NE		
<b>SV-P302</b>	17.53	20.70	1	20





Ref.	mm	INOX		
<b>SV-R336</b>	Ø 52	8.38	1	20





Ref.	mm	INOX		
<b>SV-X336</b>	60x32	10.33	1	20





Ref.	mm	INOX		
<b>SV-F336</b>	170x170	25.08	1	10



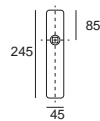

Ref.	mm	INOX		
<b>SV-G336</b>	60x32	8.63	4	20



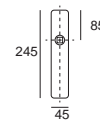
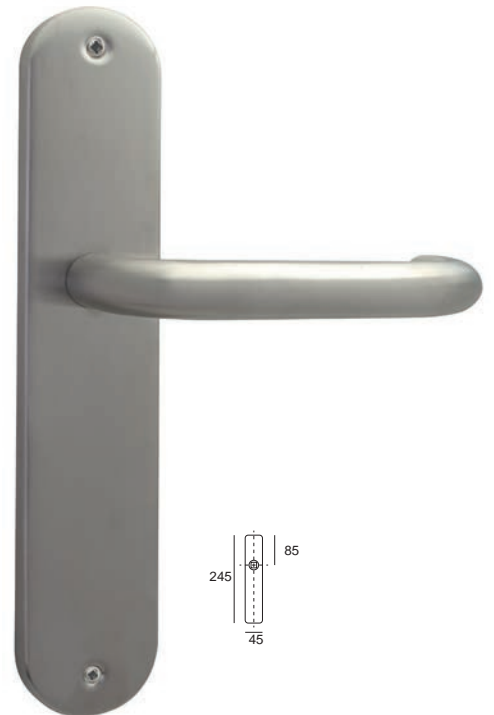

Ref.	INOX		
<b>SV-P336</b>	18.65	1	20





Ref.	INOX		
<b>SV-P337</b>	17.53	1	20







Ref.	mm	INOX	NE		
<b>SV-R338</b>	Ø 52	8.38	13.33	1	20





Ref.	mm	INOX		
<b>SV-X338</b>	60x32	10.33	1	20





Ref.	mm	INOX		
<b>SV-G338</b>	60x32	8.63	4	20

INOX, elevada  
resistencia a la corrosión



Ref.	INOX		
<b>SV-P338</b>	18.65	1	20





Ref.	INOX	NE		
<b>SV-P339</b>	17.53	20.68	1	20



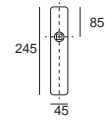

Ref.	mm	INOX		
<b>SV-R318</b> MACIZA	Ø 52	25.83	1	20
<b>SV-R358</b> HUECA	Ø 52	12.35	1	20

NEW



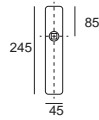

Ref.	INOX		
<b>SV-P318</b>	36.05	1	20



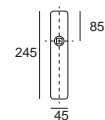

Ref.	INOX		
<b>SV-P319</b>	34.25	1	20



Ref.	INOX		
<b>SV-P334</b>	21.08	1	20



Ref.	mm	INOX		
<b>SV-C334</b>	50x50	15.88	1	20



NEW

Ref.	mm	INOX		
<b>SV-R258</b>	Ø 52	11.23	1	20



NEW

Ref.	mm	INOX		
<b>SV-C413</b>	53x53	13.35	1	20



NEW

Ref.	INOX		
<b>SV-P258</b>	14.98	1	20



NEW

Ref.	INOX		
<b>SV-P413</b>	16.08	1	20





Ref.	mm (entre cent.)	INOX	NE	
SV-M302	150	7.33	-	2
	200	9.08	10.98	1
	250	9.43	-	1
	300	9.85	-	1



Ref.	mm (entre cent.)	INOX	
SV-M318	200	34.50	1



Ref.	mm (entre cent.)	INOX	NE	
SV-M338	150	7.13	-	1
	200	9.73	12.53	1



NEW

Ref.	mm (entre cent.)	INOX	
SV-M258	200	14.90	1



Ref.	mm (entre cent.)	INOX	
SV-M365	200	23.80	1



Ref.	mm (entre cent.)	INOX	
SV-M360 (20x20)	200	18.38	2
	250	19.75	2
	300	20.85	2
	400	21.75	2
	450	22.73	2

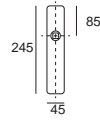
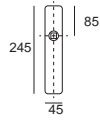

Ref.	INOX	NE	
<b>SV-MP32</b>	11.90	16.63	2

Ref.	INOX	
<b>SV-PP32</b>	13.63	2

Ref.	INOX	
<b>SV-LP30</b>	10.48	2



Ref.	mm	INOX	
<b>SV-MF32</b>	170x170	15,13	2



Ref.	mm	INOX	
<b>SV-LF30</b>	170x170	12.30	5

# MANILLONES GRAN FORMATO



NEW

Ref.	A (B)	INOX	
<b>EQ-M861</b> ■ 25 x 25 mm Desplazado 45°	400 (210)	47.03	1
	500 (300)	52.18	1
	600 (400)	59.40	1
	700 (500)	64.55	1
	800 (600)	70.73	1
	1200 (900)	101.75	1

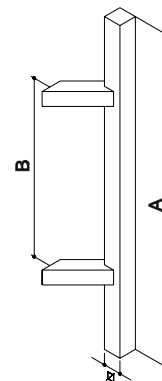



JANDEL INOX



NEW

Ref.	A (B)	INOX	
<b>EQ-M851</b> 40 x 10 mm	400 (210)	44.83	1
	500 (300)	47.75	1
	600 (400)	53.63	1
	800 (600)	68.28	1
	1200 (900)	83.52	1
	1500 (1300)	101.05	1

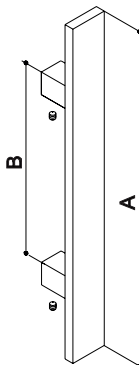



MANILLONES  
GRAN FORMATO

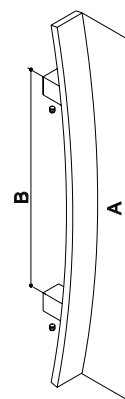

Ref.	A (B)	INOX	
<b>EQ-M841</b> 40 x 10 mm	500 (300)	57.35	1
	600 (400)	63.53	1
	800 (600)	75.90	1

JANDEL INOX



Ref.	mm (entre cent.)	INOX	
<b>EQ-M800</b> (Ø30)	300 (210)	28.88	2
	400 (300)	33.15	2
	500 (300)	36.35	2
	600 (400)	40.58	2
	800 (600)	49.15	2
	1200 (900)	61.98	2
	1500 (1300)	73.05	1
	1800 (1500)	86.95	1

Ref.	mm (entre cent.)	INOX	
<b>EQ-M810</b> (Ø30) Desplazado 45°	300 (210)	37.81	2
	400 (300)	45.50	2
	500 (300)	50.68	2
	600 (400)	57.90	2
	800 (600)	69.23	2
	1200 (900)	100.25	2

Ref.	mm (entre cent.)	INOX	
<b>EQ-M831</b> (■ 25)	300 (210)	28.88	2
	400 (300)	33.15	2
	500 (300)	36.35	2
	600 (400)	40.58	2
	800 (600)	49.15	2
	1200 (900)	61.98	2
	1500 (1300)	73.05	1
	1800 (1500)	86.95	1

\* Medidas especiales consultar con el departamento comercial



Ref.	mm (entre cent.)	INOX	
<b>EQ-M801</b> (Ø 25)	425 (400)	23.68	2
	625 (600)	30.10	2

Ref.	mm (entre cent.)	INOX	
<b>EQ-M802</b> (Ø 25)	225 (200)	26.95	2
	325 (300)	28.75	2
	625 (600)	35.15	2
	925 (900)	43.33	2
	1225 (1200)	55.05	2

Ref.	mm (entre cent.)	INOX	
<b>EQ-M802K</b> (■ 25)	225 (200)	25.98	2
	325 (300)	27.90	2
	625 (600)	33.98	2
	925 (900)	41.62	2
	1225 (1200)	52.65	2



Ref.	mm	INOX	
<b>SV-340</b>	Ø 35	8.23	1



Ref.	mm	INOX	PVLM	
<b>SV-345</b>	Ø 50	9.25	15.53	1



Ref.	mm	INOX	
<b>SV-348</b>	Ø 50	9.93	1



Ref.	mm	INOX	NE	
<b>SV-B304</b>	Ø 50	1.40	2.75	20



Ref.	mm	INOX	NE	
<b>SV-B305</b>	Ø 50	1.40	2.75	20



Ref.	mm	INOX	
<b>SV-B307</b>	Ø 50	1.40	20



Ref.	mm	INOX	
<b>SV-B309</b>	Ø 35	1.95	20



Ref.	mm	INOX	
<b>SV-346</b>	35 x 35	9.88	1



Ref.	mm	INOX	
<b>SV-347</b>	50 x 50	9.50	1



Ref.	mm	INOX	NE	
<b>SV-B303</b>	50 x 50	1.63	2.78	20



Ref.	mm	INOX	NE	
<b>SV-B308</b>	50 x 50	1.63	2.43	20



Ref.	mm	INOX	NE	
<b>SV-B306</b>	60 x 32	1.63	2.10	20



Ref.	INOX	
<b>SV-1198</b>	7.53	20



Ref.	mm	INOX	
<b>SV-HUELLA15</b>	15 x 26	2.35	25



Ref.	mm	INOX	
<b>SV-HUELLA20</b>	20 x 28	2.70	25



Ref.	mm	INOX	
<b>SV-TOPE</b>	22x30	2.80	25

JANDEL INOX





Ref.	mm	INOX	
<b>SV-8510</b>	Ø56 (Ø48 interior)	32.45	1





Ref.	mm	INOX	
<b>SV-8610</b>	Ø56 (Ø48 interior)	16.23	1



Ref.	mm	INOX	NE		
<b>SV-170P</b>	70 x 70	17.15	29.65	1	48



Ref.	mm	INOX		
<b>SV-172P</b>	Ø 85	10.70	1	48

JANDEL INOX



Ref.	mm	BL	CB	CM	NE	NM
<b>M04A</b>	45X20	2.36	2.26	2.26	2.36	1.92



Ref.	mm	CM	NM
<b>M27A</b>	25X25	1.30	1.38



Ref.	mm	CM	NM
<b>M26A</b>	34X30	2.08	2.50
<b>M26B</b>	25X21	1.24	1.82



Ref.	mm	CM	NM
<b>M28A</b>	Ø 32	2.76	3.16

Ref.	mm	CM	NM
<b>M03A</b>	192	5.20	6.38



Ref.	mm	CM	NM
<b>M07A</b>	128	3.38	4.78



Ref.	mm	CB	CM	NM
<b>M09A</b>	128	4.48	4.04	5.90
<b>M09B</b>	96	3.56	3.14	4.76





Ref.	mm	CM	NE	NM
<b>M10A</b>	192	7.76	6.66	9.64
<b>M10B</b>	128	5.38	6.04	7.04



Ref.	mm	CM	NM
<b>M11A</b>	192	11.26	11.26
<b>M11B</b>	128	8.08	8.08



Ref.	mm	CM	NM
<b>M12A</b>	192	9.12	9.03
<b>M12B</b>	160	6.20	7.88
<b>M12C</b>	128	4.54	5.74



Ref.	mm	BL	CM	NE	NM
<b>M13A</b>	240	6.78	5.04	6.76	8.70
<b>M13B</b>	160	4.78	4.20	4.56	5.06
<b>M13C</b>	128	4.38	4.16	4.16	4.74



Ref.	mm	CM	NM
<b>M14A</b>	320	6.82	8.96
<b>M14B</b>	224	5.56	7.50
<b>M14C</b>	128	3.80	4.36
<b>M14D</b>	96	3.30	3.92



Ref.	mm	CM	NM
M22A	256	7.72	7.72
M22B	160	5.14	5.14
M22C	128	4.58	4.58



Ref.	mm	NM
M23A	792 / Ø12	15.34
M23B	692 / Ø12	14.46
M23C	592 / Ø12	13.64
M23D	492 / Ø12	11.88
M23E	442 / Ø12	11.16
M23F	392 / Ø12	10.34
M23G	342 / Ø12	9.72
M23H	292 / Ø12	8.32
M23I	242 / Ø12	7.36
M23J	192 / Ø12	6.28
M23K	160 / Ø12	5.50
M23L	128 / Ø12	4.80
M23M	96 / Ø12	4.06



Ref.	mm	CM	NM
M24A	128	3.20	4.82
M24B	96	2.04	2.44
M24C	64	1.60	1.82



Ref.	mm	CM	NM
M25A	128	3.28	3.70



Ref.	mm	CM	NM
M29A	128	4.52	5.78







Ref.	mm	CM	CU
<b>H55A</b>	34x28	3.16	3.24
<b>H55B</b>	22x22	2.74	2.90



Ref.	mm	CB	CM	CU
<b>H95A</b>	47x47	10.80	6.24	9.02
<b>H95B</b>	37x37	8.64	4.76	7.10



Ref.	mm	CM	CU
<b>H76A</b>	24x21	2.52	2.86

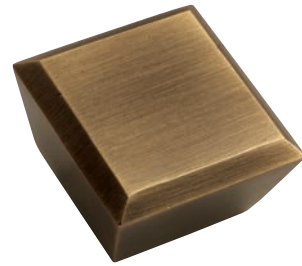

Ref.	mm	CB	CM	CU	PL
<b>H102</b>	37x37	12.88	7.02	7.88	9.16



Ref.	mm	CM	CU	PL
<b>H93A</b>	37x26	4.54	5.40	5.84
<b>H93B</b>	25x18	3.60	3.46	3.86



Ref.	mm	CB	CM	CU	PL
<b>H103</b>	23x23	8.86	3.68	4.90	5.24



Ref.	mm	CM	CU	PL
<b>H94A</b>	96	6.92	6.66	7.44



Ref.	mm	CU	PL
<b>H113</b>	128	8.26	7.92





Ref.	mm	CB	CM	CU	PL
<b>H107</b>	Ø41 (32 entre centros)	7.66	3.94	5.16	5.36



Ref.	mm	CB	CM	CU	PL
<b>H115</b>	140x28 (96 entre centros)	17.38	9.34	12.28	12.83



Ref.	mm	CB	CM	CU	PL
<b>H108</b>	Ø78 (64 entre centros)	11.46	7.22	8.26	9.01



Ref.	mm	CU	PL
<b>H120</b>	96	7.78	7.96



Ref.	mm	CB	CM	CU	PL
<b>H111</b>	96	7.82	4.16	5.50	5.58



Ref.	mm	CU	PL
<b>H121</b>	50x50	7.70	7.88



Ref.	mm	CB	CM	CU	PL
<b>H112</b>	64	7.06	3.82	4.76	4.85



Ref.	mm	CU	PL
<b>H122</b>	35x35	5.32	5.54



Ref.	mm	CB	CM	CU	PL
H123	Ø62	12.92	9.68	10.46	10.68



Ref.	mm	CB	CM	CU	PL
H124	Ø50	9.30	6.43	7.40	7.62



Ref.	mm	CB	CM	CU	PL
H125	Ø28	6.44	4.16	4.90	4.90





Ref.	mm	CU	PL
H126	50x50	9.64	9.90



Ref.	mm	CU	PL
H127	35x35	7.48	7.82



Ref.	mm	CU	PL
H128	22x22	5.28	5.40

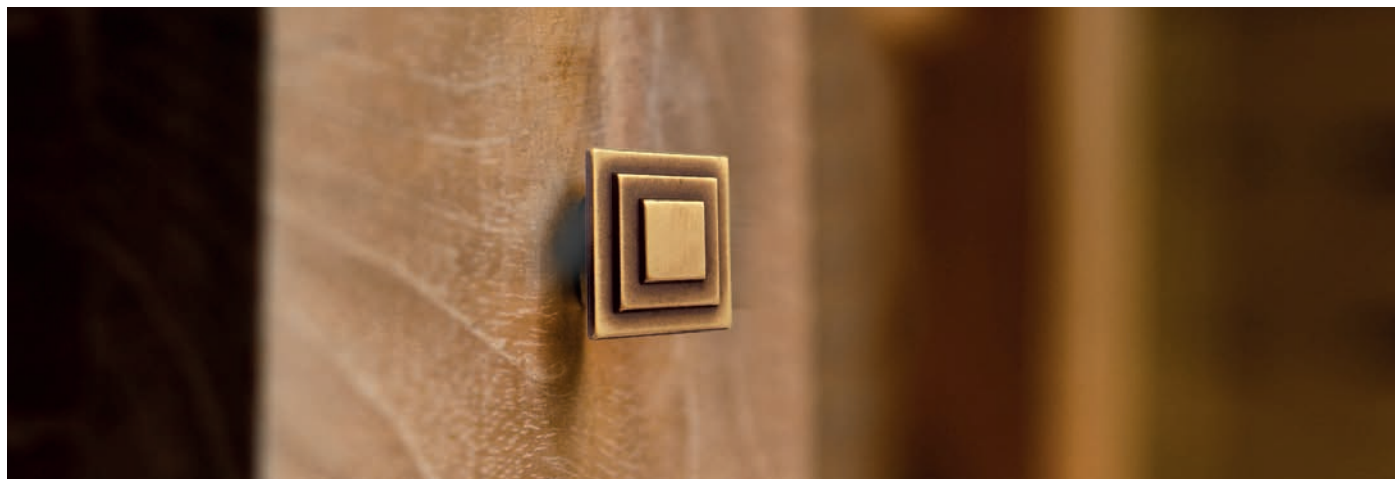





Ref.	mm	CU	PL
H129	68x68	15.38	15.52



Ref.	mm	CB	CU	PL
H132	58x58	13.70	11.58	11.72



Ref.	mm	CU	PL
H130	50x50	10.76	11.24

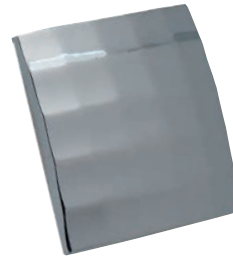

Ref.	mm	CB	CU	PL
H133	45X45	10.38	8.34	8.64



Ref.	mm	CU	PL
H131	40x40	8.44	8.90

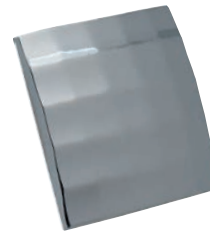

Ref.	mm	CB	CU	PL
H134	37x37	9.90	7.40	7.62

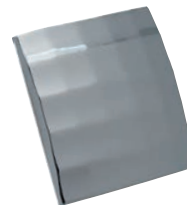

Ref.	mm	CB	CU	PL
H135	28x28	7.40	5.54	5.80



Ref.	mm	CM
<b>H136</b>	250 (128 entre centros)	14.02

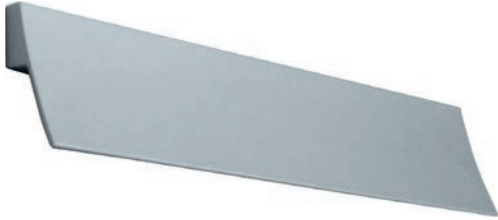

Ref.	mm	CM
<b>H137</b>	180 (128 entre centros)	10.68

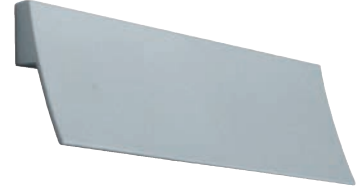

Ref.	mm	CM
<b>H138</b>	110 (64 entre centros)	7.92



Ref.	mm	CB	CM
<b>H140</b>	64 (entre centros)	12.14	7.74



Ref.	mm	NS
<b>SV-HUELLA</b>	Ø20	2.20



# jandel



[www.jandel.es](http://www.jandel.es)



C/Dels Fusters, 19. P. I. Els Mollons · 46970 Alaquàs (Valencia) Spain  
Tel. +34 963111845 · [info@jandel.es](mailto:info@jandel.es) · [pedidos@jandel.es](mailto:pedidos@jandel.es)